

ecostrad

INSTRUCTION MANUAL

Ecostrad Designer Electric Radiators

ALLORA

Horizontal

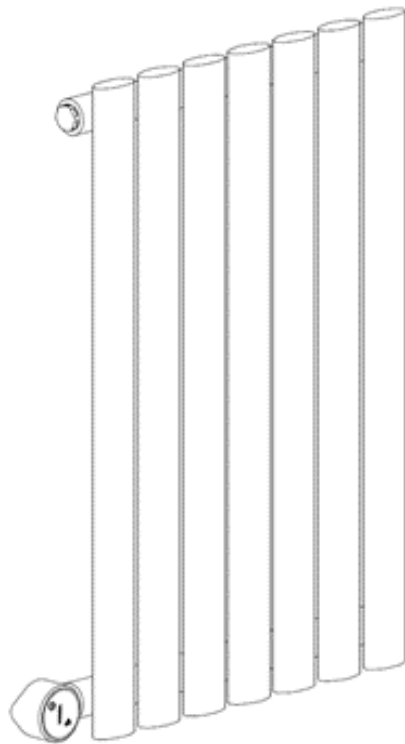

PLEASE READ AND SAVE THESE INSTRUCTIONS



Symbols



Warning

This symbol indicates a hazard with an average risk level which, if not avoided, could result in serious injury or death.



Warning of electrical voltage

This symbol indicates danger to the life and health of persons due to electrical voltage.



Hot surface

This symbol located on the device indicates that its surfaces are hot during and immediately after operation. Hot surfaces should not be touched: danger of burns.



Observe instructions in manual

This symbol located on the device indicates that instructions in the operating manual must be observed when installing and using the device.

Contents

1	About the Manual	4
2	Warnings & Precautions	4
3	Installation	5
	3-1 Components	5
	3-2 Fitting the element	6
	3-3 Wall mounting	6
	3-4 Connecting the element	9
4	Cleaning	9
5	Warranty	10
6	Disposal	10

1 | About the Manual

This manual describes the Ecostrad Allora Designer Radiator and details how to install and use the product. It is important to thoroughly review this manual before using the product.

For additional information regarding any aspect of the Ecostrad Allora Designer Radiator, contact:

Ecostrad Ltd.

Firecrest House
Lingerfield Business Park
Market Flat Lane
Knaresborough
North Yorkshire
HG5 9JA

Tel: 0330 880 7005

Email: customersupport@ecostrad.com

<https://ecostrad.com/>

2 | Warnings & Precautions

Read all safety warnings and all instructions in this manual carefully before using or installing the radiator. Failure to follow the warnings and instructions may result in electric shock, fire, serious injury, or all of the above. Save all warnings and instructions for future reference.

Check that all ancillary components are present and that the product has not suffered any damage during transit.



NOTE - This radiator is supplied with an electric heating element and is for use with an electric supply only. The product cannot be used as part of a central heating system or as a dual source radiator. This radiator has been pre-filled and adjusted for electric use. No filling is required. Do not remove any of the seals as this might cause leakages and void the warranty. Improper adjustment of the fluid level in the radiator can cause malfunction.

The radiator can be used for heating throughout the home provided it is fitted with and controlled via the supplied heating element. Consult the manual of the supplied element for full safety, installation and functionality details.



Warning

This appliance is not intended for use by persons (including children) with reduced physical, sensory or mental capabilities, or lack of experience or knowledge, unless they have been given supervision or instruction concerning use of the appliance by a person responsible for their safety. Children should be supervised to ensure they do not play with the appliance.



Warning

As with conventional radiators, this electric radiator will get hot to the touch during operation. If the radiator is left on full power for a prolonged period of time the surface temperature can rise to 70 °C (+/- 5 °C). Particular attention should be given where children and vulnerable adults are present.



Warning







When drilling or fixing into walls, floors or ceilings it is essential you check for pipes and wires before commencing. Please ensure that you wear all necessary personal protective equipment.

3 | Installation

3-1 | Components

Before beginning installation, check that all fixings in **Table 1** are supplied. The radiator should only be mounted with the manufacturer's fixings.

Table 1 | Fixings and components

Part	Description		Quantity
A	Left Brackets		3
B	Right Brackets		2
C	Bracket Guards		5
D	Wall Plugs		5
E	Washers		5
F	Wall Screws (ST6x65)		5
G	Element*		1

*The heating element is packaged separately from the radiator and may arrive in a separate delivery.

3-2 | Fitting the element

Full instructions for fitting the element can be found within the element manual. The user must ensure installation is in accordance with the following:

- The element must be fitted at the bottom of the radiator on the side. It may be fitted on the left or right side.
- The heating element must not be connected to the electric supply until it is secured inside the radiator and correctly orientated.
- The radiator is filled with an anti-freezing liquid exactly to the level required by the element. Ensure that no liquid is lost during installation.
- Do not hang the radiator with the heating element at the top (**Figure 1**).

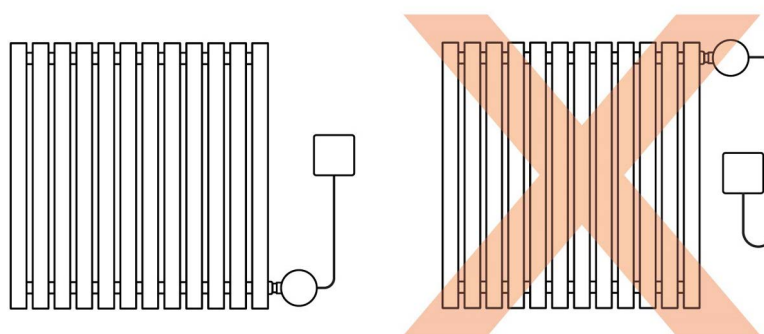

Figure 1 | Correct and incorrect element positioning

3-3 | Wall mounting

Tools required for wall mounting:

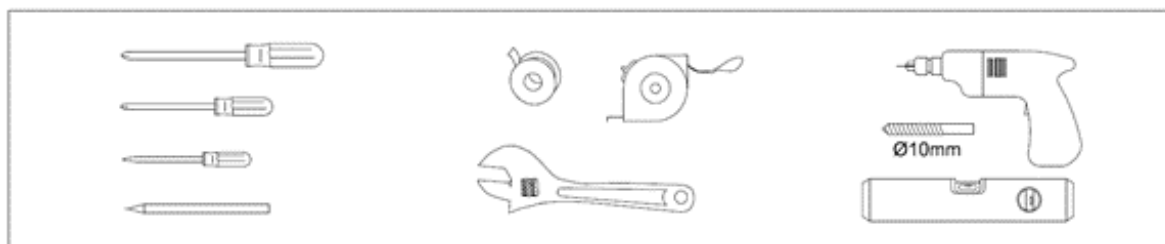

Figure 2 | Tools required

NOTE - these tools are not provided with the radiator.

1. Check that the wall is strong enough to hold the weight of the pre-filled radiator. The fixings supplied are suitable for use in solid masonry. For any other wall type you will need to source appropriate fixings. If fitting to a plasterboard wall, either fit directly to the wooden struts or otherwise strengthen the wall; do not fix through plasterboard alone.

If you are fitting the radiator to a stud wall and struggling to line the Bracket positions up with the studs, swapping one or both Bracket sets so that the back plates flip to the other side may give you the necessary flexibility. It may also be useful to choose a custom mounting position - see step 4. Additional Brackets, if required, are available on request.

2. Place the Bracket Guards (C) in the Brackets (A, B).

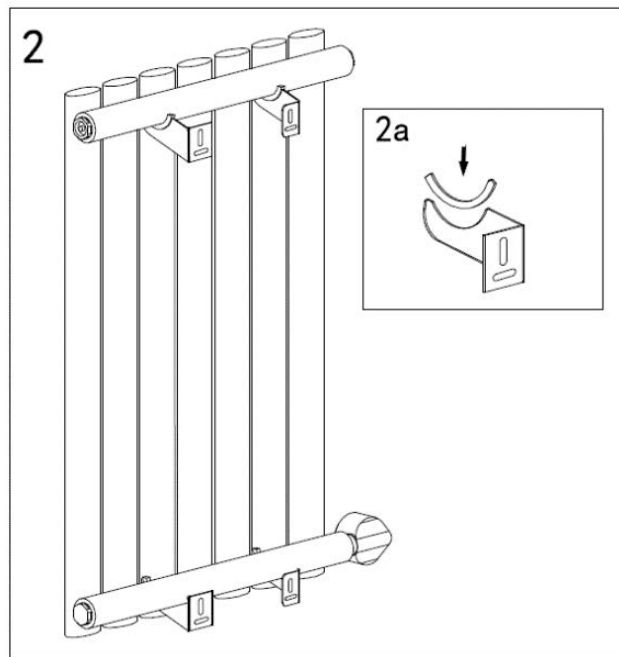

Figure 3 | Fixing the radiator Brackets

3. Choose a mounting position and affix the Brackets (A, B) accordingly.
 - a. Use the template provided in the box to mark the Bracket positions on the wall (see Figure 4).

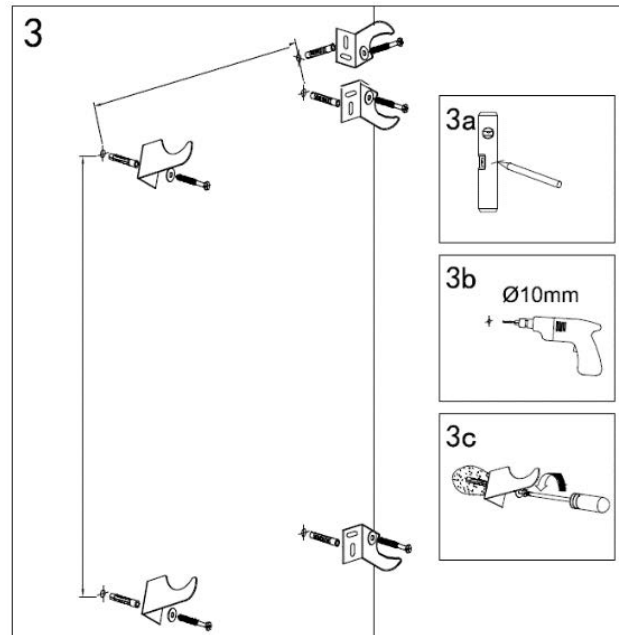

Figure 4 | Fixing the wall Brackets

- b. Using a 10mm drill bit, drill four holes in the marked locations and push the Wall Plugs (D) inside.
 - c. Position the Brackets (A, B) over the holes and fix in place using the Washers (E) and Wall Screws (F). The Brackets (A, B) should slot between the bars with their mounting plates facing together: with the Left Brackets

- (A) on the left and the Right Brackets (B) on the right as you face the radiator (see **Figure 4** above).
4. If you require your Left (A) and Right (B) Brackets to be spaced closer together or farther apart, for example when affixing to studs in a stud wall, you can choose custom Bracket positions.
 - a. Choose the point where the Brackets will sit between the radiator bars, according to your requirements.
 - b. The Brackets (A, B) should slot between the bars with their mounting plates facing together: with the Left Brackets (A) on the left and the Right Brackets (B) on the right as you face the radiator.
 - c. Use a tape measure, spirit level and the positions decided in step **a** above to mark the Bracket positions on the wall (see **Figure 5**).

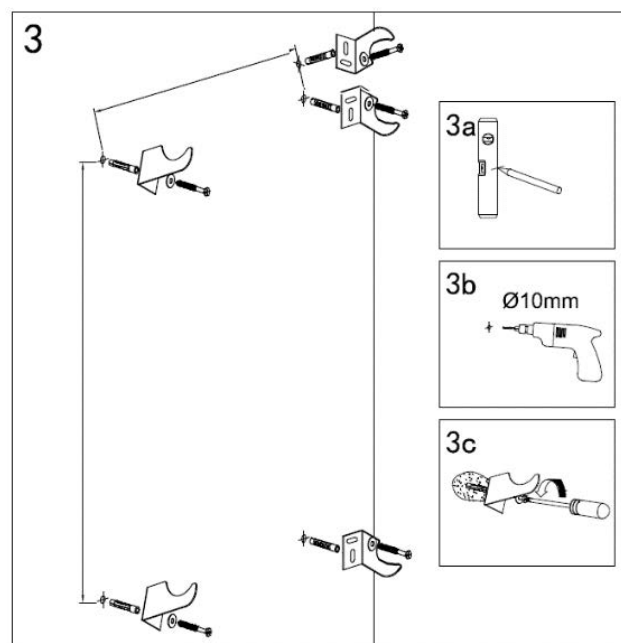

Figure 5 | Fixing the wall Brackets

- d. Using a 10mm drill bit, drill four holes in the marked locations and push the Wall Plugs (D) inside.
 - e. Position the Brackets (A, B) over the holes and fix in place using the Washers (E) and Wall Screws (F).
5. The radiator is now ready to mount. You may choose to add the optional security Bracket at this stage, see **Figure 6**.
 - a. Lift the radiator onto the Brackets (A, B).
 - b. **OPTIONAL** – Position the remaining Bracket (A) pointing downwards above one of the top Brackets, such that the radiator top bar is now locked in place. Mark the Bracket location on the wall before lifting the radiator off the Brackets.

- c. Use the 10mm drill bit to drill the marked Bracket hole and push the remaining Wall Plug (D) inside. Replace the radiator, re-position the Bracket and use the remaining Washer (E) and Wall Screw (F) to fix.

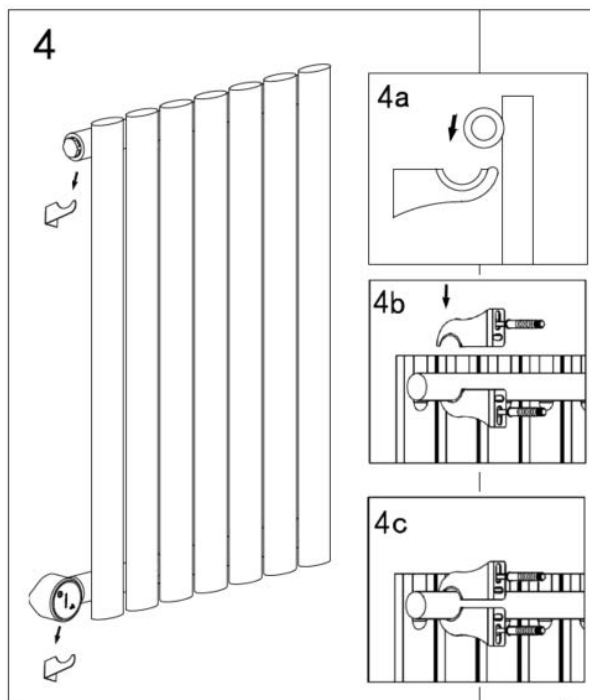



Figure 6 | Securing the radiator to the wall

3-4 | Connecting the element

Wiring the heating element to the mains is a job for a qualified electrician. Please consult the element manual for full instructions and safety warnings, paying special consideration to the following:

- The radiator and its element are designed to be used under AC 230 voltage and should be connected to the household fixed wiring by a qualified electrician in accordance with national wiring regulations. Risk of electric shock. 
- Do not install the radiator under or in front of a power socket or connector box.
- The power lead must be connected to a socket which must be at least 25cm from the floor. Do not connect the element to the power supply until it is secured within the radiator and correctly orientated, as demonstrated in **Figure 1**.

4 | Cleaning

Regular cleaning with a soft, damp cloth will keep the surface of your product looking new. Do not use abrasive or chemical cleaners as these will damage the finish over time.

5 | Warranty

The Ecostrad Allora Designer Radiator carries a 10-year guarantee on the steel body, a 3-year guarantee on paintwork and a 2-year guarantee on electrical components. Within the stated period, starting from the date the customer receives their unit, Ecostrad guarantee to repair or replace the unit where a fault is due to defects in materials or manufacturing.

The warranty does not cover any defect arising from damage, negligence, usage outside the product's intended purpose or fair wear and tear. The warranty is only valid when the radiator has been used with the supplied heating element, at the specified supply voltage, and in accordance with all conditions specified in this manual. The warranty will be void if the radiator has been tampered with, if its fluid levels have been adjusted, or if the ratings label has been removed.

The warranty does not cover failures and faults due to force majeure, accidental damage, mishandling, external impact, chemical agents or atmospheric phenomena, incorrect use of the unit, the purchaser's faulty electrical installations, transporting the unit or problems caused by the unit being handled by persons not authorised by Ecostrad. An invoice may be required to confirm that installation work has been carried out by a qualified professional. Ecostrad cannot accept responsibility for damage, loss or injury caused by incorrect installation, maintenance, cleaning or covering the unit.

The warranty is a contract with the original purchaser and does not transfer if the unit is re-sold, gifted or inherited. Proof of purchase, including order number and order confirmation or invoice, will be required if a claim is made. The warranty covers only the model of heater shown on the purchase invoice. The warranty covers the repair or replacement of the defective product only and Ecostrad shall have no liability for installation costs or consequential losses however incurred. Claims must be made with the establishment where the unit was purchased. This warranty does not affect the customer's consumer rights.

6 | Disposal



In accordance with WEEE Directive 2012/19/EU, the icon with the crossed-out waste bin on electrical or electronic equipment stipulates that this equipment must not be disposed of with household waste at the end of its life. You will find collection points for free return of waste electrical and electronic equipment in your vicinity. The addresses can be obtained from your local authority.

The separate collection of waste electrical and electronic equipment enables the re-use, recycling and other forms of recovery of waste equipment, and prevents any negative effects for the environment or human health caused by the disposal of hazardous substances potentially contained in the equipment.