



Manual de instalación y uso  
Instructions & installation manual  
Manuel d'installation et utilisation  
Manual de instalação e uso

# RCTTS Inerzia



Español

English

Français

Português



[www.haverland.com](http://www.haverland.com)  
[www.haverland.co.uk](http://www.haverland.co.uk)

**ES****ÍNDICE**

4	<b>1. ADVERTENCIAS GENERALES</b>
6	<b>2. INSTALACIÓN</b>
9	<b>3. FUNCIONAMIENTO</b>
9	3.1 PANEL DE CONTROL
9	3.2 INICIO - PRIMERA CONEXIÓN
10	3.3 MODO ANTIHIELO
10	3.4 MODOS DE CALEFACCIÓN
11	3.5 MODO MANUAL
12	3.6 CONFIGURACIÓN DEL TERMOSTATO
14	3.7 AJUSTE DEL RELOJ
14	3.8 AJUSTE DÍA DE LA SEMANA
15	3.9 AJUSTE TEMPERATURA CONFORT
15	3.10 AJUSTE TEMPERATURA DE ECONOMÍA
16	3.11 PLANES HORARIOS
19	3.12 FUNCIÓN INDICADOR CONSUMO"
19	3.13 FUNCIÓN AHORRO "VENTANAS ABIERTAS"
20	3.14 FUNCIÓN INTELIGENTE ITCS
21	3.15 APAGAR EL DISPLAY
22	3.16 BLOQUEO DE TECLADO
22	3.17 CAMBIO DE IDIOMA
23	3.18 DESCONEXIÓN RED ELÉCTRICA / CORTE SUMINISTRO
23	<b>4. MANTENIMIENTO</b>

**EN****INDEX**

24	<b>1. CAUTION</b>
26	<b>2. INSTRUCTIONS FOR INSTALLATION</b>
29	<b>3. OPERATION</b>
29	3.1 CONTROL PANEL
29	3.2 START - FIRST CONNECTION
30	3.3 ANTI-FREEZE MODE
30	3.4 HEATING MODES
31	3.5 MANUAL MODE
32	3.6 SETTING THE THERMOSTAT
34	3.7 SETTING THE CLOCK
34	3.8 SETTING THE DAY OF THE WEEK
35	3.9 SETTING THE COMFORT TEMPERATURE
35	3.10 SETTING THE ECONOMY TEMPERATURE
36	3.11 TIME SCHEDULES
39	3.12 CONSUMPTION INDICATOR FUNCTION
39	3.13 "OPEN WINDOWS" FUNCTION
40	3.14 INTELLIGENT ITCS FUNCTION
41	3.15 SWITCH OFF THE DISPLAY
42	3.16 KEYBOARD LOCK
42	3.17 CHANGING THE LANGUAGE
43	3.18 DISCONNECTION FROM THE MAINS / POWER CUT
43	<b>4. MAINTENANCE</b>

## 1. CAUTION

- **Please read these instructions carefully.**
- To disconnect mains power from the radiator remove the plug from the wall socket, but never pull on the cable.
- Do not leave the mains cable in contact with the radiator when it is switched on.
- During operation, the radiator must be kept well away from combustible materials, such as curtains, carpets and furniture etc.
- **The warranty for the radiator does not cover any damage caused by not reading these instructions.**



**WARNING:** In order to avoid overheating, do not cover the heater.



• **WARNING:** If the mains power cable is damaged, it must be replaced by the manufacturer, with their after-sales service or similar qualified persons, in order to prevent any danger.



• **WARNING:** If the heater is to be installed in a bathroom, it must be positioned so that it cannot be touched by anybody in the bath or shower.



• **The installation should be carried out with consideration to the manufacturer's instructions and in accordance to the relevant National Wiring Regulations BS7671.**

- It is very important that radiator has a good Electric Earth connection.
- The radiator shall be installed so that its mains plug is always accessible.
- The radiator must not be installed below or in front of a mains socket.
- **This radiator cannot be surface-mounted with a wall. Safety distances shall always be respected.**
- **The radiator has a keyboard blockage option to prevent children from changing the programming.**
  - This unit is not designed to be handled by persons (including children) with physical, sensorial or mental handicaps, with little experience or knowledge unless they are under the supervision of an adult responsible for their safety with the instructions on its use. Children shall always be supervised to ensure they do not play with the unit.
  - Children under three shall be kept well away from the heater unless they are continually supervised.
  - Children between three and eight shall only switch the unit off or on providing it is positioned or installed in its final operating location and be supervised or have received instructions on how to use the unit in a safe manner and understand the risks involved.
  - Children between three and eight shall not plug in, adjust or clean the heater or carry out any maintenance operations.
  - This unit may be used by children older than eight and by persons with physical, sensorial or mental handicaps, with little experience or knowledge, provided they have been duly trained and are supervised by an adult that understands the risks involved.
  - Cleaning and maintenance shall be performed by adults not children. Children must not play with the unit.
- **WARNING:** Certain parts of this product can become very hot and cause burns. Special attention shall be paid when children and other vulnerable persons are present.





- Do not touch the external parts of the radiator when it is operating.
- It is quite normal that, with the first switch-on, the unit produces a “new” smell. Allow your heater to operate in a well-ventilated place for two or three hours.
- Before the first switch on for the coming winter or when the heater has not been used for several days, the unit should be cleaned (follow the steps given in the “maintenance section”). This cleaning operation will avoid burning the accumulated dust and other remains.
- This radiator **CAN'T OPERATE** with external programmable controllers or any other exterior control device.
- **CAUTION:** Keep bags and other accessories well out of the reach of children.
- The convection effect, together with other ambient factors, can cause discolouring to metal surfaces and to plastics.
- Temperature differences can cause crackling and other noises in the unit. This does not indicate any failure in the radiator.
- The regulations on discarding oil when the heater is being disposed of must be observed.
- When the radiator is disposed of, the requirements established by current legislation on waste processing and recycling shall be taken into account.

**IMPORTANT**

- It is important that the radiator **IS FIXED FIRMLY TO A SOLID AND LEVELLED WALL.**
- Make sure that there is a socket near the area where you are going to place it.
- Take out the wall pattern from the box to see the exact positions of the necessary drill holes.
- You must keep a minimum distance of 15 cm between the radiator and any object, wall or combustible material.

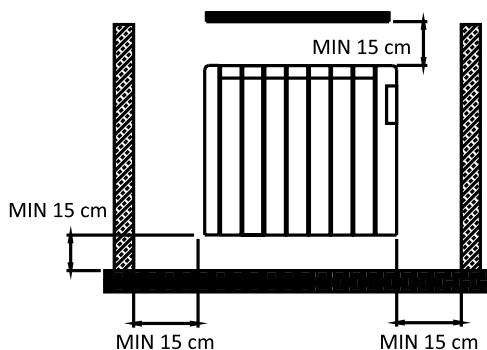

1

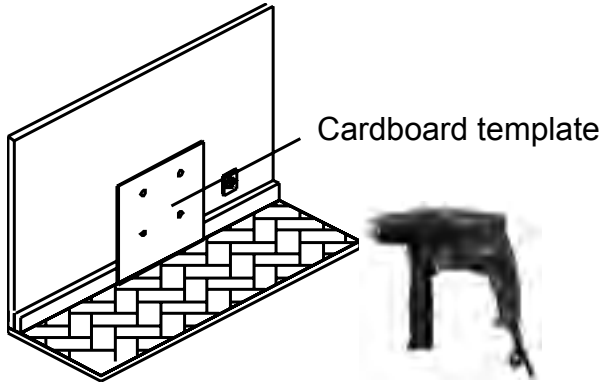

2

Place the screw  
but don't  
screw it fully.  
(M. 6 x 40 mm)

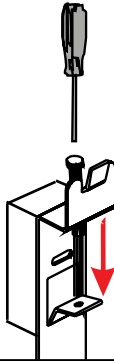

3

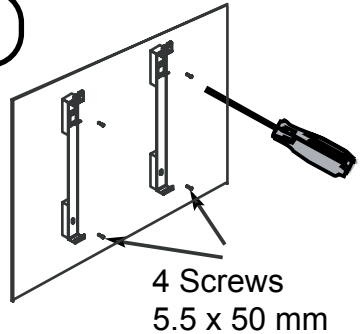

4

Place  
the radiator

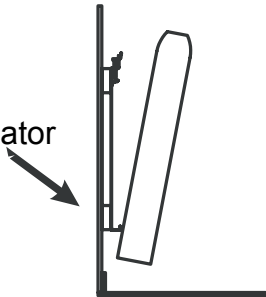

5

Slide the  
radiator up,  
Place over top  
tang and lower  
gently into  
position

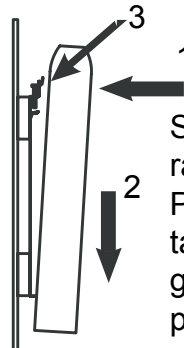

6



**IMPORTANT:**  
Screw down  
**FULLY** to lock  
the radiator

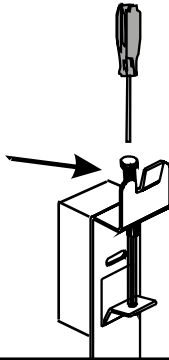

7

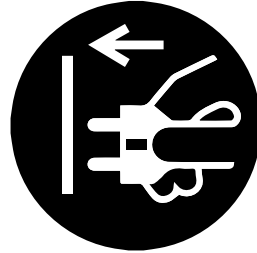

8

Press ON /  
OFF switch  
located at the  
right rear part  
of the unit.

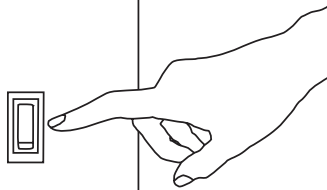

### INFORMATION

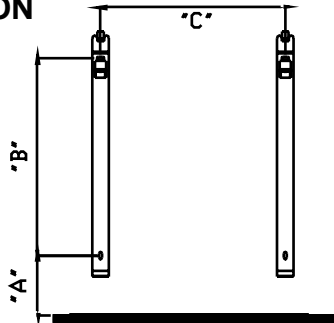

(W)	"A" (mm)	"B" (mm)	"C" (mm)
900	420	246	319
1200	420	246	478
1500	420	246	638
1800	420	246	638

## 3.1 CONTROL PANEL

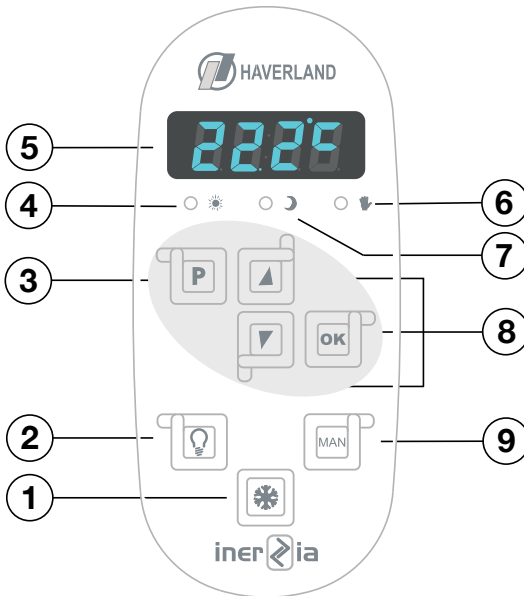

1. Anti-freeze mode button
2. On/off screen light Manual mode button
3. Programming menu button
4. Comfort LED (programming mode)
5. Screen
6. Manual mode LED
7. Economy LED (programming mode)
8. Selection of temperatures and other parameters
9. Manual mode button

## 3.2 START - FIRST CONNECTION

When the radiator is connected to the mains, press the switch on the position ON:

1. If this is the first time the radiator is connected, "Pr:Hd" will appear flashing on the screen.
2. Press OK button . The room temperature will then be displayed.

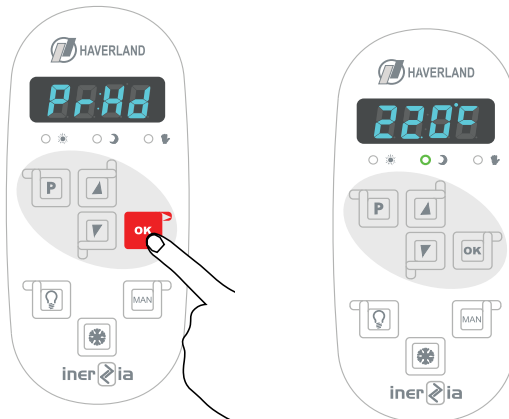



## 3.3 ANTI-FREEZE MODE

By pressing the  button, the radiator changes from “anti-freeze mode” to “heating mode” and vice versa.

The room temperature will be displayed



The economy LED (moon) will flash approximately every 5 seconds to indicate “anti-freeze mode”.

## Anti-Freeze Mode



Flashes every 5 seconds

## Heating Mode



Remember that you can switch to “anti-freeze mode” by pressing the button .

Thanks to this “**anti-freeze mode**”, extreme temperatures will be avoided in your home, keeping the room temperature at 7°C.

## 3.4 HEATING MODES

In heating mode, the radiator has two modes of operation, PROGRAMMING mode or MANUAL mode.

Choose the mode of operation by pressing MANUAL  button.

## Programming Mode

Hand LED switched off



## Manual Mode

Hand LED switched on



## Programming Mode

In programming mode, the radiator can be in a comfort, economy or anti-freeze cycle.

-  Confort Led
-  Economy Led
-  Economy Led flashing: antifreeze



## Manual Mode

Hand LED switched on



The comfort (sun) and economy (moon) LEDs will be switched off.



Remember that you can switch to “anti-freeze mode” by pressing the  button.





For an efficient use of your radiator, we recommend using the programming mode. Programme your radiator with the specific times that you require heating in the room.

## 3.5 MANUAL MODE



In manual mode, the radiator operates as an ambient thermostat.

Once the manual mode has been chosen (hand LED switched on), press the  or  button to configure the desired temperature.

After a few seconds, you will return to the home screen where the room temperature of the room will be displayed.

You can view the chosen temperature at any time by pressing the  or  button.



A bright blue dot will flash on the right side of the screen when the radiator is heating.

## 3.6 SETTING THE THERMOSTAT

To access the set-up menu, **press the  button for 2 seconds**. This will open up the options menu.

With the  button, you can access the sub-menus you want to adjust. The options of the set-up menu are shown in the following diagram:

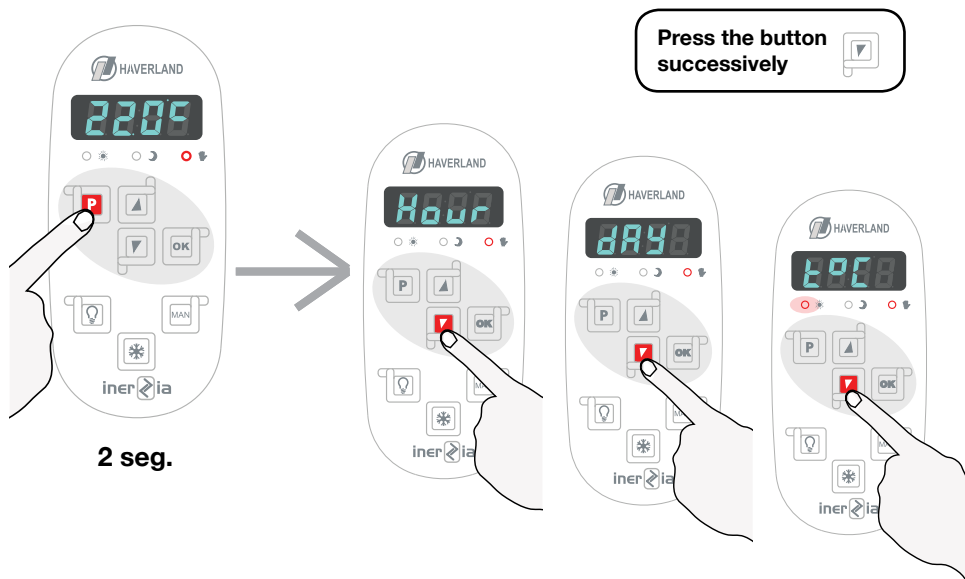



To exit the set-up menu, press the  button.

## 3.7 SETTING THE CLOCK

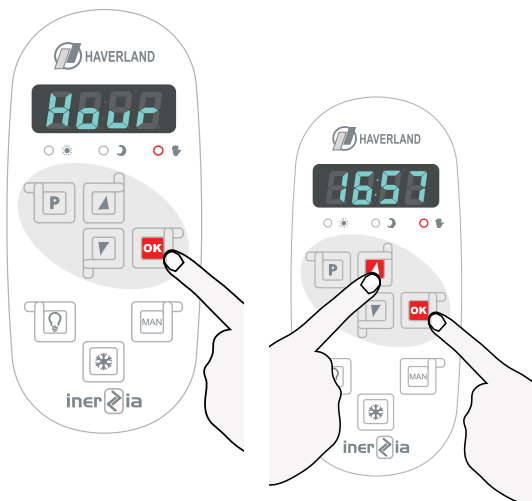

In the “Hour” sub-menu, you can set the current hour and minutes.

Press . The first two digits will flash. Set the current hour by pressing the and buttons.

Press . The minutes will flash. Follow the same procedure by using the arrows to adjust them.

Finish by pressing the button. It will take you to the next set-up sub-menu.



To exit from the set-up menu, press .

## 3.8 SETTING THE DAY OF THE WEEK

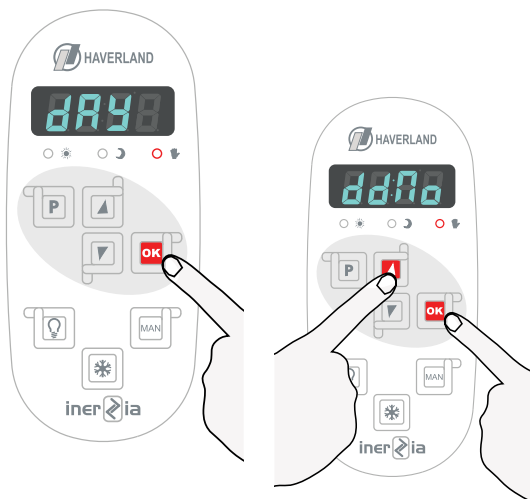

Press . The day of the week will flash.

With the and buttons, set the current day of the week (Mo for Monday, Tu for Tuesday and so on).

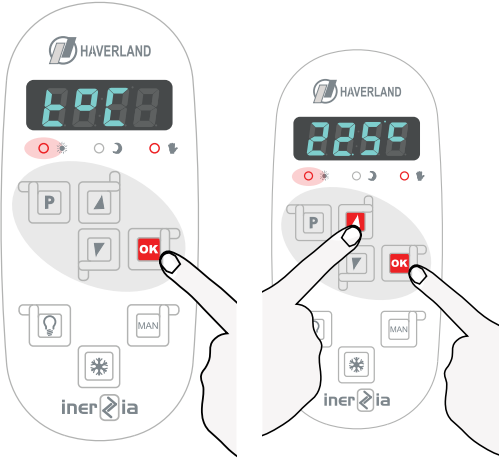

Finish by pressing the button. It will take you to the next set-up sub-menu.

## 3.9 SETTING THE COMFORT TEMPERATURE



In this sub-menu you can set the desired comfort temperature for the comfort cycles.

The minimum comfort temperature you can set is 5°C and the maximum 32°C. Taking in count that this temperature can not be lower than the economy temperature selected below.

This temperature is adjusted by using the  and  buttons

Finish by pressing the  button. It will take you to the next set-up sub-menu.

 The recommended comfort temperature is 21°C.

## 3.10 SETTING THE ECONOMY TEMPERATURE

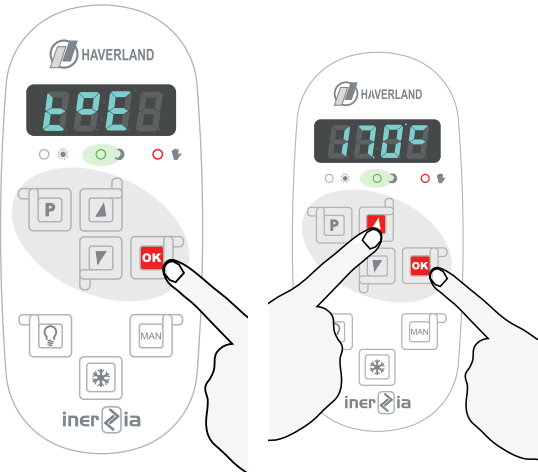

In this sub-menu you can set the desired economy temperature for the economy cycles.

The minimum economy temperature you can set is 5°C and the maximum 32°C. Taking in count that this temperature can not be higher than the comfort temperature .

Finish by pressing the  button. It will take you to the next set-up sub-menu.

 The recommended economy temperature is 17°C.

### 3.11 TIME SCHEDULES

The radiator has **4 preset programmes schedules**, configured from the factory, and a **bespoke program**, which can be modified by the user.

These four preset programs are suited for the majority of heating situations you may need.

In this sub-menu you can choose one of the 4 time schedules or the bespoke plan

- PL01:** - Comfort on Monday to Sunday from 10am to 12am. Remaining hours, economy.
- PL02:** - Comfort on Monday to Friday from 7am to 9am, 12pm to 4pm and 6pm to 12am. Remaining hours, economy.  
- Comfort on Saturday and Sunday from 10am to 12am. Remaining hours, economy.
- PL03:** - Comfort on Monday to Friday from 6am to 9am and 4pm to 12am. Remaining hours, economy.  
- Comfort on Saturday and Sunday from 10am to 12am. Remaining hours, economy.
- PL04:** - Comfort on Monday to Friday from 6am to 9am and 7pm to 12am. Remaining hours, economy.  
- Comfort on Saturday and Sunday from 9am to 11am, 2pm to 4pm and 8pm to 12am. Remaining hours, economy.

The **“PLCF” bespoke program can be modified**. By default, it is set with the following schedule:

- PLCF:** - Comfort on Monday through Friday from 7am to 2pm and 3pm to 7pm. Remaining hours, economy. On Saturday and Sunday, economy.



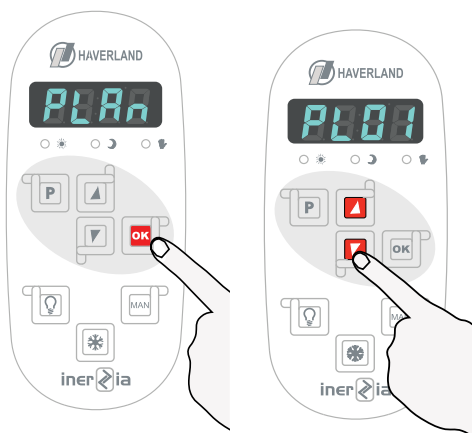

The comfort and economy cycles will take into account the comfort and economy temperatures predefined in the previous steps (points 3.9 and 3.10).

### PL01, PL02, PL03 and PL04 preset programme schedules:





Once the word **“PLAN”** is displayed on the sub-menu, press  to enter the time schedules into the sub-menu.

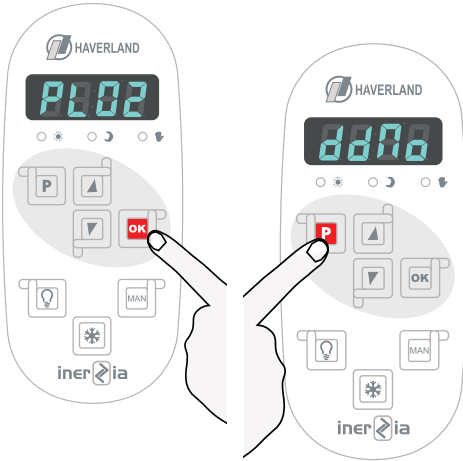

The **“PL01”** plan will be displayed on screen.

Then, press the  or  buttons to choose the desired programming schedule.

Choose one of the four preset time schedules, for example **“PL02”**.



Next, press the  button to confirm the chosen time schedule (this will appear on the “ddMo” screen).

 If you wish, you can then check the chosen time schedule by successively pressing the  button.



To validate the chosen plan and complete the setting process, press the  button.

 A bright blue dot will flash on the right side of the screen when the radiator is heating.

 The radiator follows the chosen time schedule in accordance with the comfort and economy temperatures chosen in points 3.9 and 3.10 of this manual.

## Configurable PLCF time schedule:

With the bespoke “PLCF” plan you can create a program that suits your needs, day by day and hour by hour.

Choose “PLAN” on the sub-menu, and once you have chosen the configurable “PLCF” plan, press . “ddMo” will be displayed. Then, press  to continue.

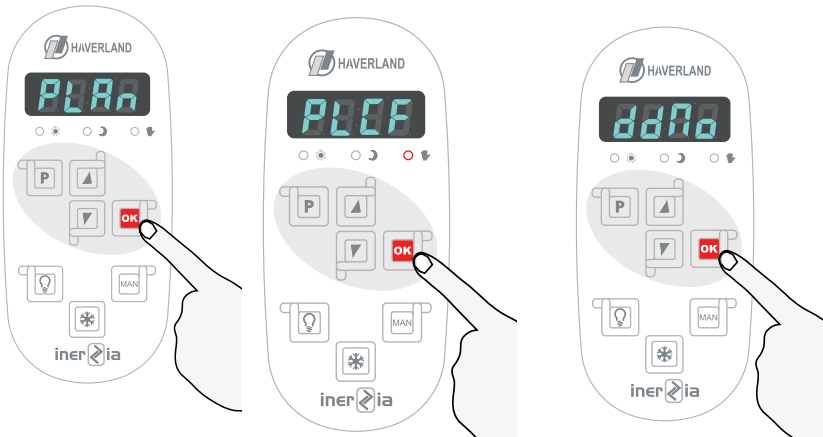



Then 00:00 will be displayed. With the  or  buttons, choose the operating cycle: comfort, economy, or anti-freeze, for the first time period (from 12am (00:00) to 1am (01:00)):

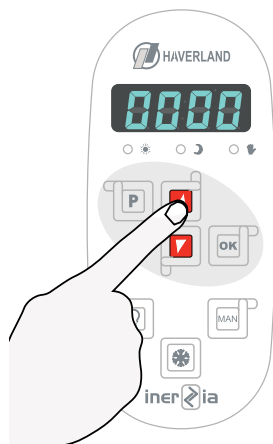

Comfort Cycle = Sun Red LED switched on 

Economy Cycle = Moon Green LED switched on 

Anti-freeze Cycle = Green LED flashing 



**The anti-freeze temperature is set at 7°C.  
This temperature can not be changed.**

Press  to switch to the next time slot (from 1am to 2am) and repeat the above process to choose the desired operating cycle (comfort, economy or anti-freeze). Repeat the process hour by hour y day by day.



Once you have set the time schedule for the entire week, the radiator will follow this chosen plan. Please make sure that the radiator is on the **PROGRAMMING mode** (hand LED switched off).





A bright blue dot will flash on the right side of the screen when the radiator is heating.



In the "PLCF" plan, the radiator follows the time schedule defined by the user, according to their needs and in accordance with the indicated comfort, economy or anti-freeze cycles.



If you wish to change a specific time slot, please select the day of the week and search for that time slot by pressing the  button. Once you have made the changes, in order to exit the menu please press the  button repeatedly until you exit of the sub-menu and the room temperature is displayed again.

## 3.12 CONSUMPTION INDICATOR FUNCTION

The radiator incorporates a function that is unique on the market, which enables you to find out its electricity consumption.

Once positioned on the “WAT” sub-menu, press  to access this function.

The energy meter will tell you the sum of the accumulated kWh every 24 hours up to the latest restart.

This meter is restarted every 30 calendar days. It can also be restarted at any time by pressing the  button for 2 seconds.

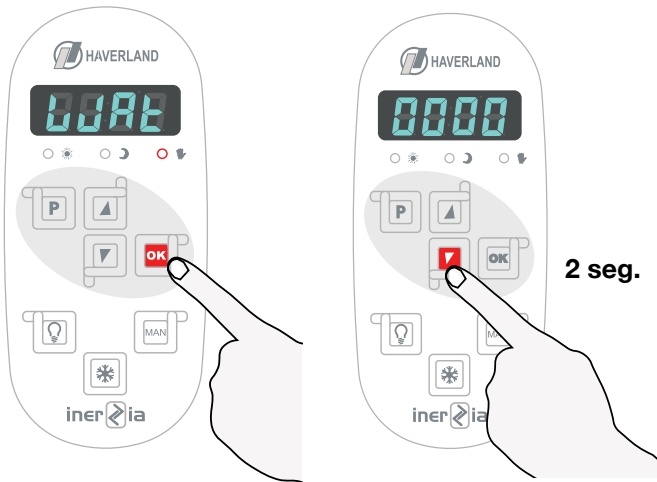

## 3.13 "OPEN WINDOWS" FUNCTION



This function is activated when there is a sudden drop in temperature in the room.

When this function activates, the green “moon” LED will flash and the radiator will switch to Antifreeze mode, avoiding an unnecessary energy consumption.

When the window is closed, the radiator will detect a rise in temperature and this function will deactivate. The radiator will switch on again, returning to the state it was in before it was disconnected.



This function can be activated or deactivated by the user. Once positioned in the “Win” sub-menu, press  to access this function.

Next, press the  or  buttons to choose “ON” or “OFF” which activates or deactivates this function.

Then press  to validate. Press  to exit from the menu.

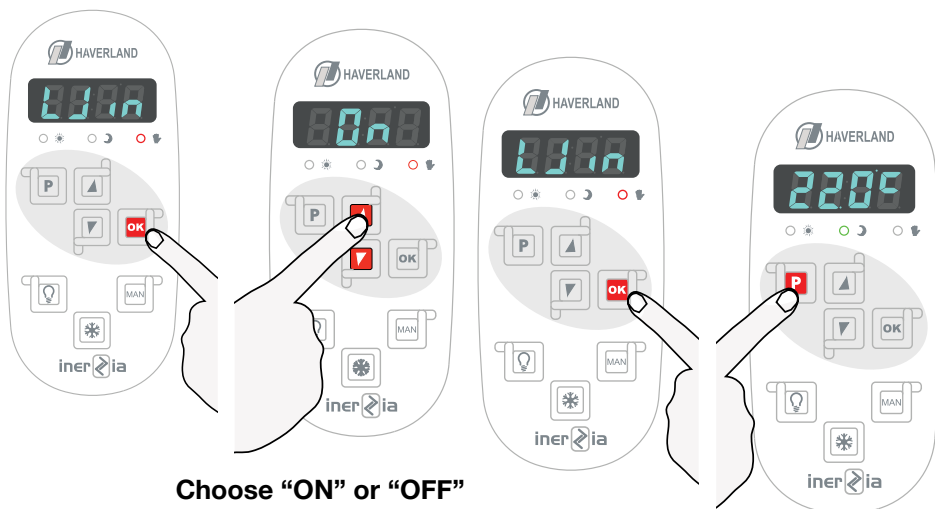

### 3.14 INTELLIGENT ITCS FUNCTION

The radiator incorporates an innovative intelligent ITCS temperature control system.

This system activates the start-up of the radiator prior to the programmed time (2 hours maximum), to ensure that the desired temperature is achieved at the indicated time and following the established weekly programme.

This intelligent function is factory set. It can be deactivated by the user.



This function can be activated or deactivated by the user. Once positioned in the "ItcS" sub-menu, press to access this function.

Next, press the or buttons to choose "ON" or "OFF" which activates or deactivates this function.

Then press to validate. Press to exit from the menu.

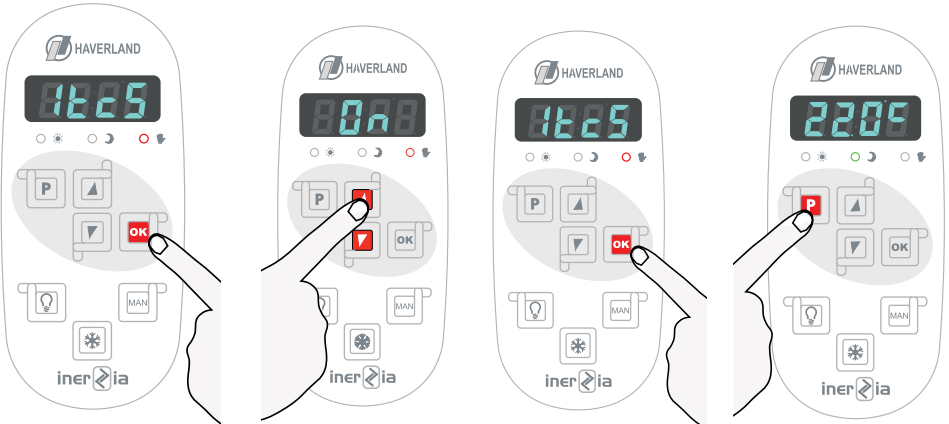

Choose "ON" or "OFF"



The C segments will rotate when this ItcS function is activated.



## 3.15 SWITCH OFF THE DISPLAY

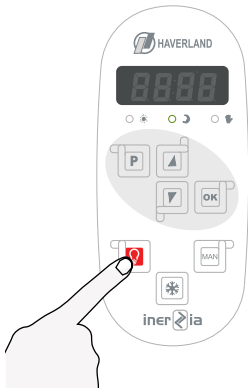

To switch off the screen, press the button.

Press the button again to switch the screen back on.



The mode indicator lights will remain turned ON. A bright blue dot will flash on the right side of the screen if the radiator is heating.

## 3.16 KEYBOARD LOCK

Simultaneously press the  and  buttons until “Loc” is displayed.

The same operation must be followed to unlock the keyboard. Then “unlo” will be displayed.

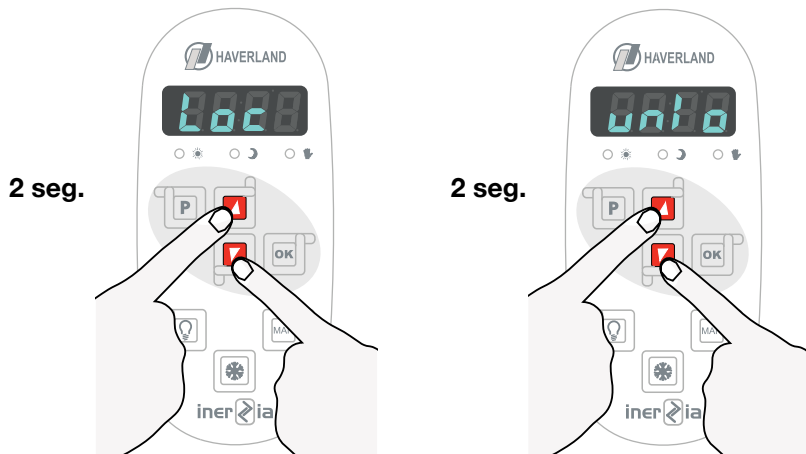

## 3.17 CHANGING THE LANGUAGE

The menu of the radiator can be set into various languages (English, French and Spanish).

Access the set-up menu by pressing the  button for 2 seconds.

Press the  button to change from one language to another.

When you have chosen the desired language, press the .

Press the  button to exit from the set-up menu.

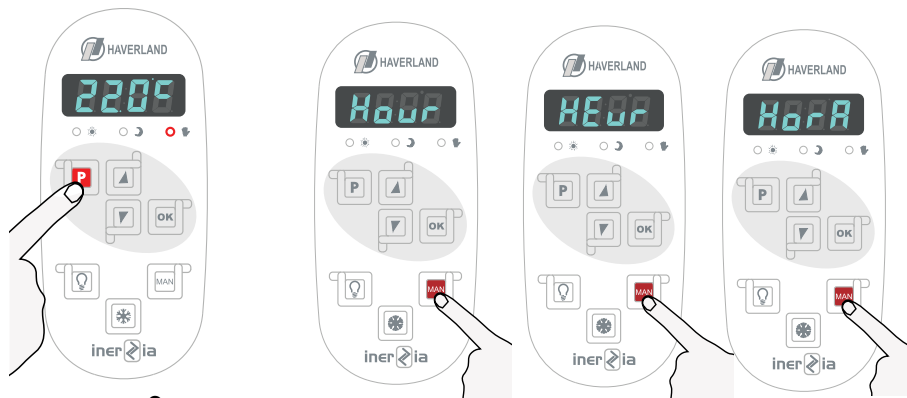

## 3.18 DISCONNECTION FROM THE MAINS/POWER CUT

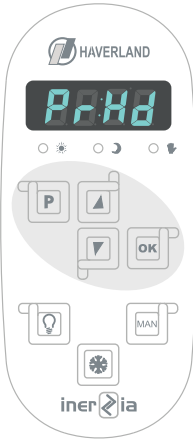

If there is a disconnection from the mains or a power cut that lasts more than 24 hours, you must re-set the day and time.

See point 3.2 regarding “START-UP - FIRST CONNECTION” manual. Set the day and time again by following points 3.7 and 3.8 on this manual.

If the electricity disconnection or power cut supply lasts less than 24 hours, all parameters will be maintained. It will even remember the last operating modes and chosen comfort and economy temperatures.

## 4. MAINTENANCE

Your heater does not need any kind of special maintenance.

Just remove any dust with a soft dry cloth.

We recommend to start the winter season, by cleaning off the dust that has built up on the heater surface.



**NEVER USE SOLVENTS OR ABRASIVE PRODUCTS.**



Where you see this symbol on any of our electrical products or packaging, it indicates that the relevant electrical product should not be disposed of as general household waste in Europe. To ensure the correct waste treatment of the product, please dispose of it in accordance with any applicable local laws or requirements for disposal of electrical equipment. In so doing, you will help to conserve natural resources and improve standards of environmental protection in treatment and disposal of electrical waste.

	W	N <sup>o</sup>
RC6TTS	900	6
RC8TTS	1200	8
RC10TTS	1500	10
RC12TTS	1800	12

**230 V 50 Hz**

**CLASS I - IP 24**

## GUARANTEE

MARSAN INDUSTRIAL, S.A. guarantees that the devices comply with the contracted specifications.

This warranty only covers the model of heater showed on the valid invoice.

Such rectifications will be guaranteed against any manufacturing and operating defect for the normal and domestic use of this product, for a period of 24 months as from the purchase date shown on the invoice.

HAVERLAND guarantees against material, design or manufacturing faults at the moment of its original acquisition for 2 years. The electronic component and paintwork / finish for 3 years (exclude accidental damage, transport, and misuse).

This warranty only covers the device whose model appears on the purchase invoice.

This warranty DOES NOT COVER incorrect installation, maintenance, cleaning or conserving the device, and neither does it cover failures and faults due to force majeure, chemical agents or atmospheric phenomena, incorrect use of the device, the purchaser's faulty electrical installations, transporting the device or problems caused by the device being handled by persons not authorised by MARSAN INDUSTRIAL, S.A.

This warranty must not be modified, altered or extended, and the Manufacturer does not authorise anybody to act on his behalf to modify, alter or extend it.

This warranty applies only to the Product.

To repair the device, the consumer must dial the Technical Assistance Service at 0330 3651940 or send an email to [haverland@haverland.co.uk](mailto:haverland@haverland.co.uk) and ask for the information needed about the procedure to follow:

For a replacement, cancellation or price reduction, when in order, the consumer must go the establishment where the device was purchased. This warranty does not affect the consumers' rights as established in the provisions contained In Ley 23/2003, the Consumer Goods Sales Guarantee Act.



**Customer Service Telephone:**  
**0330 3651940**



**E-mail: [haverland@haverland.co.uk](mailto:haverland@haverland.co.uk)**

Haverland UK Limited  
Challengue House  
Sherwood Drive  
Bletchley MK3 6DP

**Made in Spain**

Marsan Industrial, S.A. reserves the right to modify without previous warning

Modelos / Models / <i>Modèles / Modelos</i>		RC6TTS	RC8TTS	RC10TTS	RC12TTS
<b>Potencia calorífica / Heat output / <i>Puissance thermique / Potência calorífica</i></b>					
<b>Potencia calorífica nominal (kW)</b> Nominal heat output (kW) <b><i>Puissance thermique nominale (kW)</i></b> <i>Potência calorífica nominal (kW)</i>		0.9	1.2	1.5	1.8
<b>Potencia calorífica máxima continuada (kW)</b> Maximum continuous heat output (kW) <b><i>Puissance thermique maximale continue (kW)</i></b> <i>Potência calorífica continua máxima (kW)</i>		0.9	1.2	1.5	1.8
<b>Consumo auxiliar de electricidad / Auxiliary electricity consumption / <i>Consommation d'électricité auxiliaire / Consumo de electricidade auxiliar</i></b>					
<b>A potencia calorífica nominal (kW)</b> At nominal heat output (kW) <b><i>À la puissance thermique nominale (kW)</i></b> <i>À potência calorífica nominal (kW)</i>		0.9	1.2	1.5	1.8
<b>A potencia calorífica mínima (kW)</b> At minimum heat output (kW) <b><i>À la puissance thermique minimale (kW)</i></b> <i>À potência calorífica mínima (kW)</i>		0.9	1.2	1.5	1.8
<b>En modo de espera (kW)</b> In standby mode (kW) <b><i>En mode veille (kW)</i></b> <i>Em estado de vigília (kW)</i>		N.A.	N.A.	N.A.	N.A.
<b>Tipo de control de temperatura interior</b> Type of heat room temperature control <b><i>Type de contrôle de la température de la pièce</i></b> <i> Tipo de comando da temperatura interior</i>	<b>Con control electrónico de temperatura interior y temporizador semanal</b> Electronic room temperature control plus week timer <b><i>Contrôle électronique de la température de la pièce et programmeur hebdomadaire</i></b> <i> Com comando eletrônico da temperatura interior e temporizador semanal</i>				
<b>Otras opciones de control</b>	<ul style="list-style-type: none"> <li>- Control de temperatura interior con detección de ventanas abiertas</li> <li>- Con control de puesta en marcha adaptable</li> </ul>				
Other control options	<ul style="list-style-type: none"> <li>- Room temperature control, with open window detection</li> <li>- With adaptive start control</li> </ul>				
<b>Autres options de contrôle</b>	<ul style="list-style-type: none"> <li>- <i>Contrôle de la température de la pièce, avec détecteur de fenêtre ouverte</i></li> <li>- <i>Contrôle adaptatif de l'activation</i></li> </ul>				
<i>Outras opções de comando</i>	<ul style="list-style-type: none"> <li>- <i>Comando da temperatura interior, com deteção de janelas abertas</i></li> <li>- <i>Com comando de arranque adaptativo</i></li> </ul>				
<b>Nombre del fabricante / Name del fabricante / <i>Nom du fabricant / Nome do fabricante</i></b>	<b>Marsan Industrial, S.A.</b>				
<b>Dirección / Address / <i>Adresse / Endereço</i></b>	<b>Avda. San Martín de Valdeiglesias, Km 2.2 28925 Alcorcón (Madrid)</b> <b>España / Spain / <i>Espagne / Espanha</i></b>				



**HAYERLAND®**

**RCTTS inercia**