

Manual-Installation TTB-E Duo+



Model

- **TTB-E Duo+**



Please note and keep!
Changes reserved!
No.: GB 900 322 767

Edition:02/20

General Information

We would like to thank you for your confidence in our storage heaters. Experience has shown: TECHNOTHERM stands for competence. Now and in the future.

GB

To allow an easy and safe use of your electric storage heater, we are enclosing this manual.

The use of the appliance is very easy, however, we recommend you take the time to read carefully this manual. It gives you important information on installation, safety, use and maintenance of this appliance. Retain this manual carefully and pass it on to the eventual next owner!



We do not accept any responsibility if any of the following instructions are not respected.

- Dispose all the packing materials in accordance with the local regulations

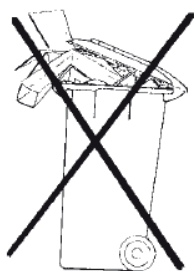

- Check the condition of the appliance at delivery. All transport damage should be reported within three days of delivery and before installation.
- If, in spite of visible damage, an appliance is installed, we will not accept any claims.
- To ensure a secure operation of the appliance, the present manual must be strictly respected. The storage heater must be installed by a qualified electrician only

- Do not use the appliance for any other than the described purpose.
- Service and manipulation are to be made by a professional only.
- Appliances which are no longer used should be disconnected immediately and the connecting cables should be cut through. Dispose the appliance in accordance with local regulations.

NOTE: Electric storage heaters are very heavy!

Before placing the heater, check the stability of the floor with an expert.

The floor surface must be flat and even. The appliance can be placed on any kind of floor, but deformation may occur to the floor covering due to the heat and the weight of the appliance (e.g. with PVC, parquet floor and light coloured carpets).

Security

Due to the high surface temperature of the appliance, the following distances must be kept:

To the wall	min. 2 cm
From a windowsill (brick)	min.15 cm*)
From a flammable windowsill (e.g. wood)	min. 20 cm*)
In front of the air outlet grille of the heater, in all directions	min.50 cm
Between two heaters	min 3 cm

*) If the cover juts out horizontally over the front panel for x cm, the distance vertically must be additionally raised in the same measure (x cm more). (see fig. 2)

The appliance may have hot surfaces depending on the charging status.

Attention!!

Do not cover the appliance! Always leave free space around the heating appliance. Do not let any object touch the appliance!

Do not place curtains and or other textiles in front of the hot air outlet. Danger of fire! Do not place any inflammable products or thermal isolating objects, such as paper, clothes, and aerosol cans on or in the near proximity of the heater.

The heater must be properly fixed to the wall (see page 11).

Do not install electric storage heaters in rooms where contact with flammable or explosive materials like dust, gas or vapour cannot be avoided. This refers also to a short time usage of the heater while any kind of floor covering work is done, and where dust is created or gas or flammable products are used. In any of these circumstances the heater should not be charged and must be covered, especially at the air outlet grille. For installation in commercial buildings (e.g. workshop, hair-dressing salon, laboratories, etc.), please contact your professional association.

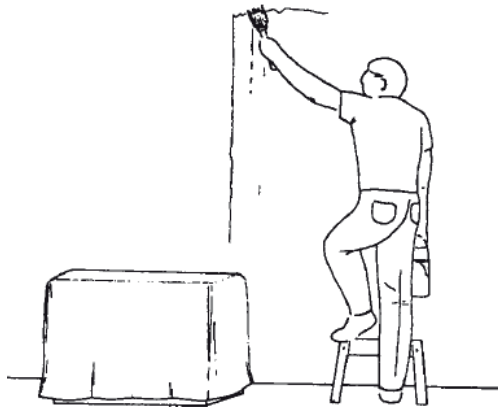

Maintenance

Clean the heater, preferably when it is cold, with a humid cloth and afterwards with a soft dry rag. Do not use any flammable or abrasive products to clean the heater. The cleaning should be done regularly in order to prevent any permanent stains on the heater due to dust parts burning or particles glued to the panels.

Mounting instruction, reserved to the professional installer

Place

Please follow the safety guidelines for installation, security and load bearing capacity mentioned in this manual. In case of doubt concerning the floor resistance, seek the advice of an architect.

The stability of the appliance must be guaranteed: place the appliance on a flat surface. For a correct functionality, avoid placing the heater on a carpeted or tiled floor which is not even and/or completely horizontal.

To prevent accidents and possible tipping of the heater, it must be fixed to the wall with safety screws, supplied with the heater. The necessary screws and plugs are found in the lower part of the switchboard in a plastic bag.

If the wall is not strong enough a more adequate fixing material has to be used.

Installation

For safety against tipping fix the rear chimney panel (4) with appropriate screws and plugs to the wall.

Fix the drill holes and the plugs according to the instructions in fig. 1 and fig. 2 and the type of appliance.

For this purpose, loosen two screws (8) on the rear panel, take the rear chimney panel (4) away and fix it horizontally to the wall. At least two of the mounting holes (9) must be used (see fig. 2 and table 1).

After making sure the rear chimney panel is properly fixed to the wall, the appliance can be suspended in the rear panel slot.

Important:

The fixing to the wall of the rear chimney panel is done exclusively for safety against tipping. Note that the appliances are only suitable for wall mounting above the floor if wall consoles or already available runners are used.

Important:

When the appliance is filled with bricks, it may sink somewhat into the pile when placed on thick-pile carpeting.

GB

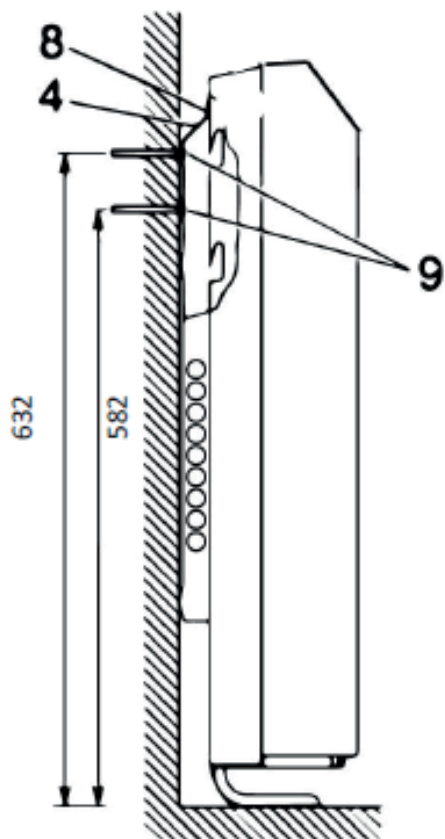

Model	Measure A	Measure B	Measure C
TTB-E Duo 08	180	-	357
TTB-E Duo 17	110	325	587
TTB-E Duo 26	103	333	800
TTB-E Duo 34	133	536	1011

Fig. 2

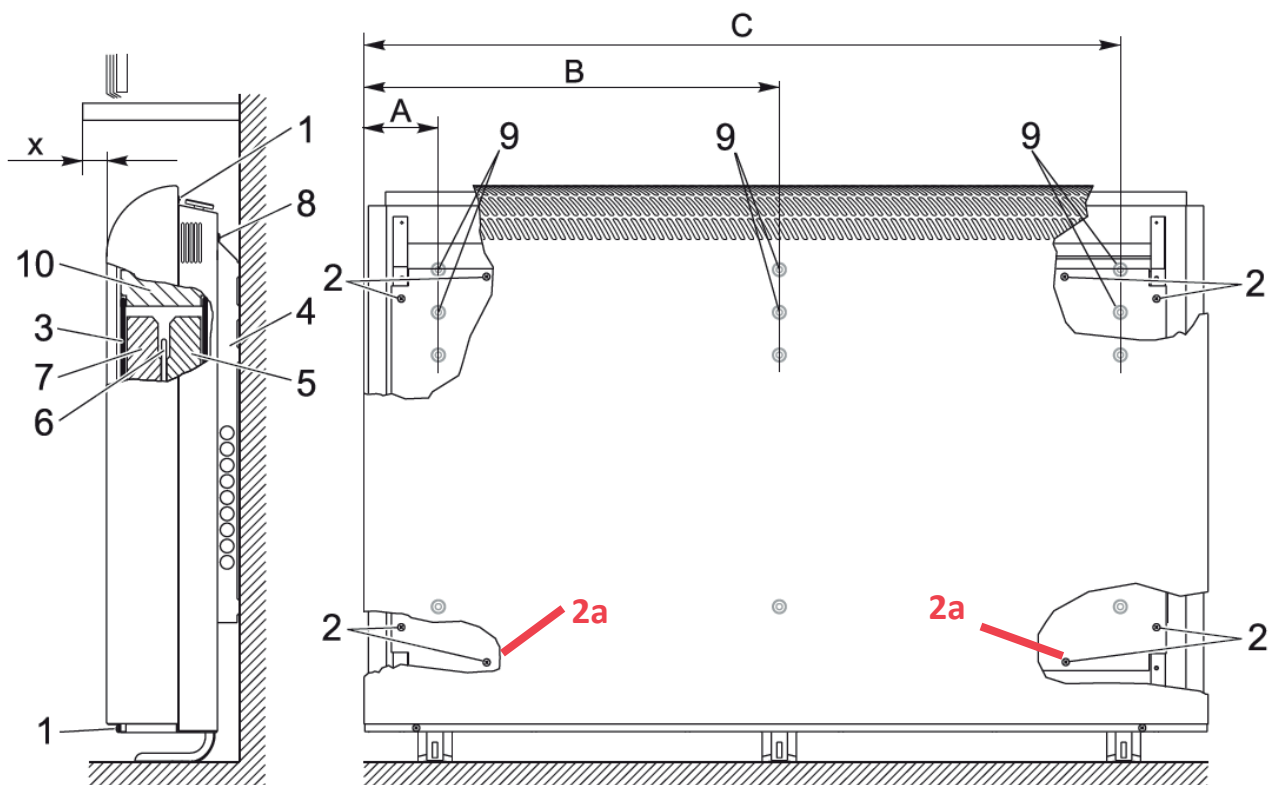

Opening

Loosen the screws (1) (Fig 2) and remove the front panel.

Be careful not to break the connection cable to the thermostat

GB

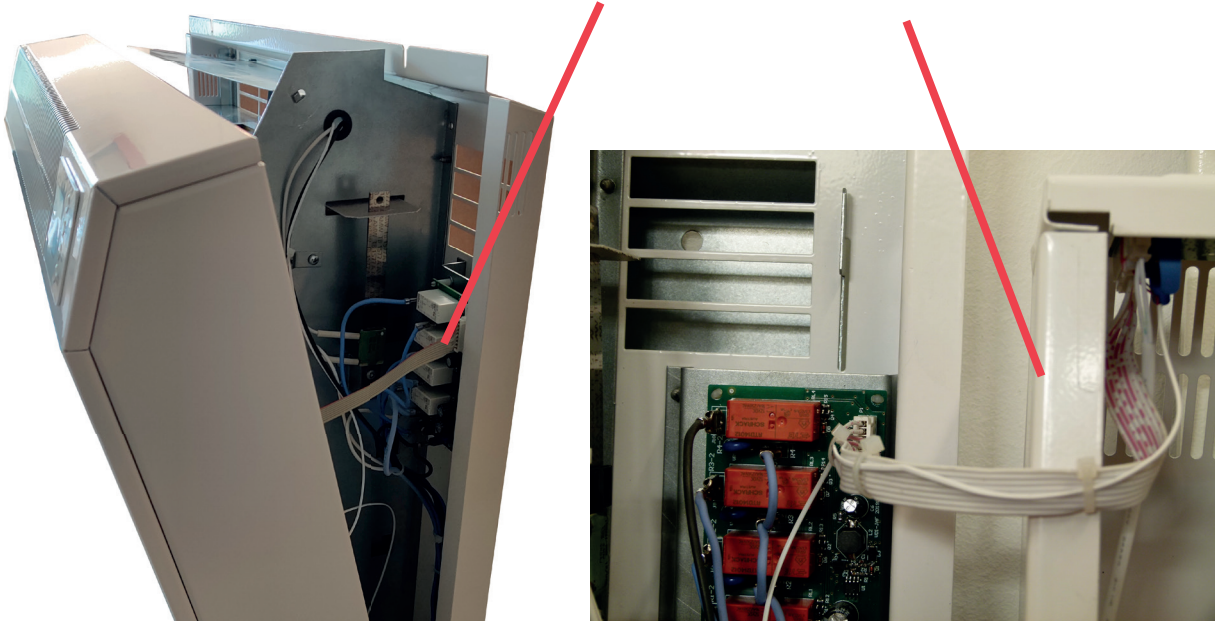

Loose the six screws (2) - not 2a! - on the inner front panel and remove them together with the insulating panel that is fixed to it. The screws 2a are behind the additional heater and can not be reached. The inner front panel needs to be „slid“ in or out the screw 2a to be fixed!

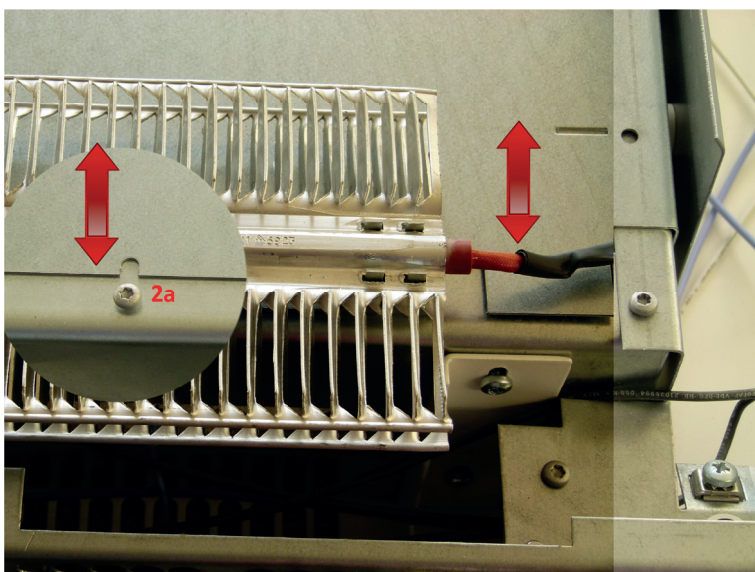

The core is now opened. The cardboard can be removed from the core area.

Inserting the bricks and closing

Check when fitting the bricks that the heating element connections remain tight and have not been loosened in transit. To insert the rear storage brick (5) tip the heating elements (6) forward (do not remove the plug). The bricks have to be flat and fit closely to the rear panel insulation. After this, put the heating elements in the right position again.

Attention:

Absolutely respect the order of the bricks. Please observe closely the size of the heating element. Bricks #07 must be placed on the left side. Place the front bricks (7) with the contact surface tightly on the rear bricks (5). See Fig 2 on page 4.

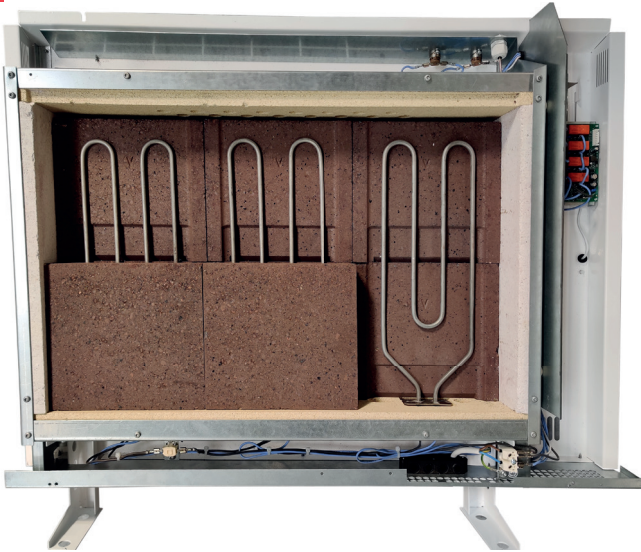

Attention: The front surface of the bricks has to end evenly the relief for the insulating panel on the upper insulation block (10). (fig. 2, left)

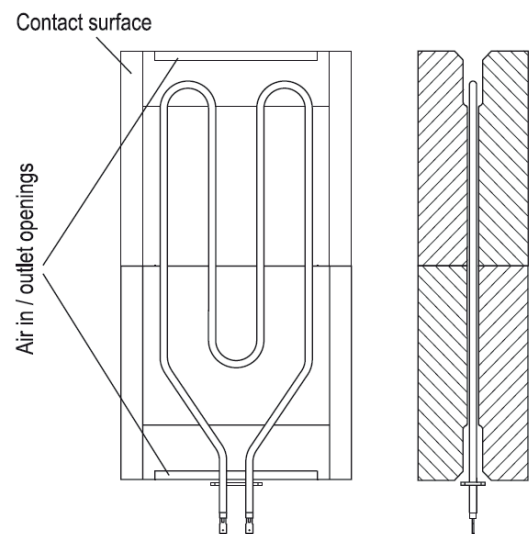

Screw the inner front panel to the front panel again.

Attention! Make sure the insulating panel (3) is placed correctly! Then, screw the inner front panel to the front panel again. Make sure that the inner front panel is „slid“ into the two screws 2a again.

Attention:

The white insulating panels (3) must not to be damaged and must therefore be handled with care during the installation.

Wiring

The wiring and connection of the heater has to be done accordingly to all relevant safety standards and rules. The guidelines of the local electricity utility must also be followed. The appliance has protection Class I and must be earthed. Feed the supply cables in from the underside of the appliance through the cord anchorage and to the terminal block. Connect the wires to the terminals. At the terminal all the electric wire for charge will be done. You can find the wiring diagram on the inside of the front panel.

The installation has to be equipped with an all pole circuit breaker, allowing, in case of any intervention, to cut off the power supply of the appliance.

Attention: do not place any socket in the direct proximity of the appliance. Due to the low voltage guidelines installations - new and existing ones - have to be equipped with an earth leakage protection device sensitive also to direct current pulses. The installation of the appliance must be done by a licensed electrician. This appliance is not determined for use by people (including children) with limited physical, sensory or mental abilities or lack of experience and/or lack of knowledge unless they are supported by a person responsible for their safety or received instructions from such a person on how to use it. Children should be supervised to ensure that they do not play with the appliance.

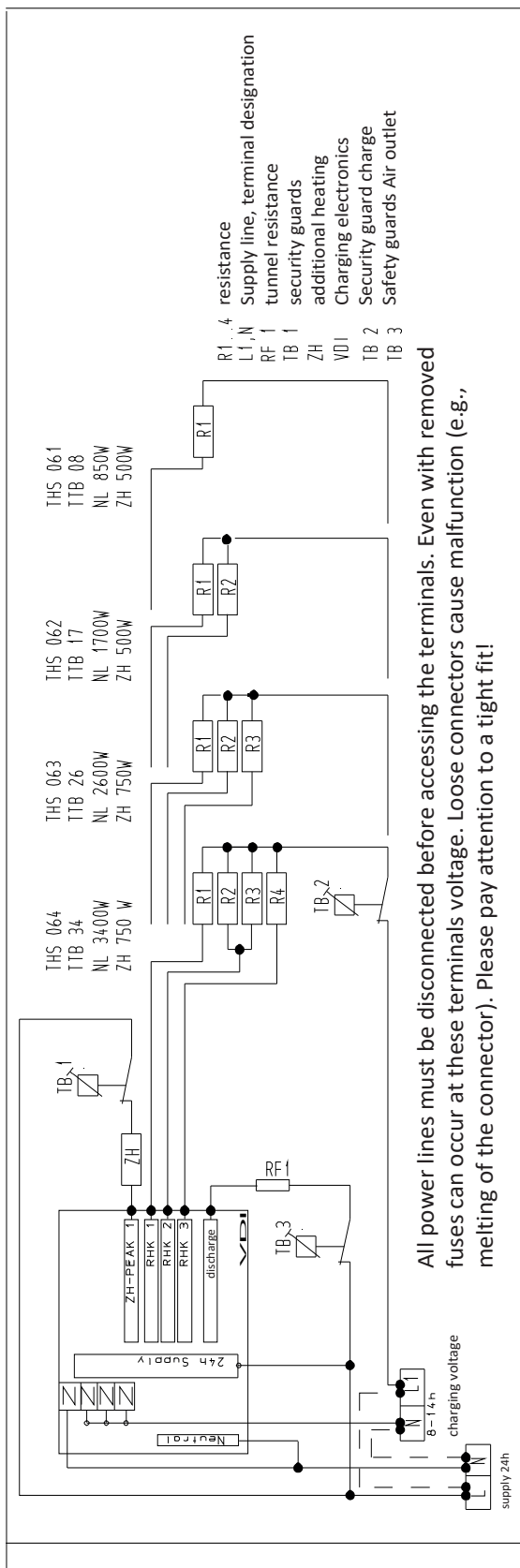

All power lines must be disconnected before accessing the terminals. Even with removed fuses can occur at these terminals voltage. Loose connectors cause malfunction (e.g., melting of the connector). Please pay attention to a tight fit!

Before any intervention on a terminal make sure that the power supply is switched off.

Terminals may be under live voltage, even if the all pole circuit breakers have been switched off.
Terminals not correctly tightened may lead to disfunction (fusion of terminals).
Attention! Check that terminals are correctly tightened.

Connection option 1:

GB

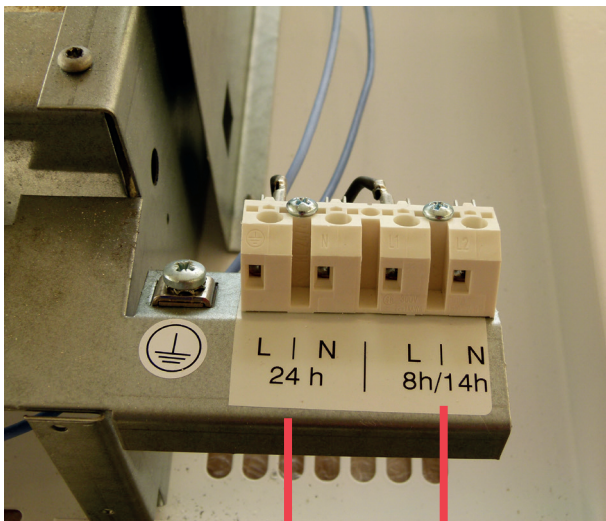

(24h Supply)

(8h/14h Charge Power)

Connection option 2:

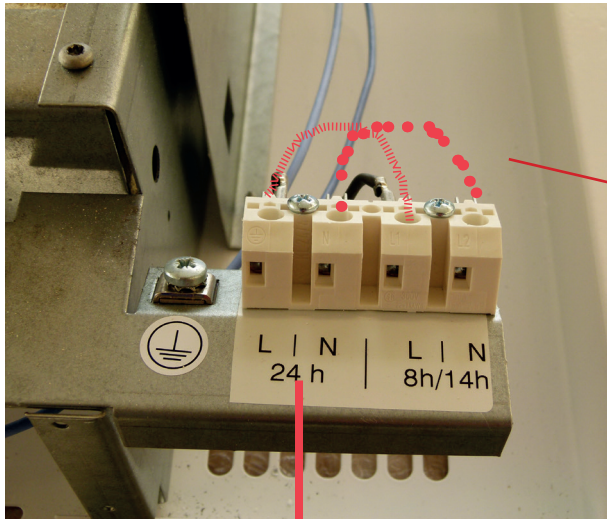

Bridge with red cable.
Cable is included.

(24h Supply)

+ (8h/14h Charge Power)

Checking the appliance

At the end of assembling and wiring, the function of the appliance has to be checked.

Before making use of the appliance, make the following tests:

Test the insulation with a test voltage of at least 500 V. The insulation resistance has to be at least 0,5 MΩ.

Before switching on the power supply, check the voltage level of the network. Check the charge (e.g. by means of a kWh-meter and a time measurement). As an alternative, a cold measurement of the ohm value can be made.

GB

System Start-up

The first charge must be controlled by a qualified electrician.

By using high performance thermal insulation, the first charge of the appliance does not have to be done at its maximum. It is still necessary to ventilate the room after the first use (e.g. open a window).

If the appliance is moved and has been in use before, the steps above mentioned have to be followed. When performing the first charge (by a qualified electrician) you must wait until the charge controller switches off and measure the charge acceptance in kWh. The charge may not exceed the values of maximum charge mentioned in table 2, page 10. The charge must not be higher than the maximum charge in cold status.

After the installation has been completed, this manual and all related manuals must be handed over to the owner or the final user of the appliance.

Attention!

If the heater was already in use before and has been moved, the thermal insulation must be checked to see if it is still in good condition. If necessary, replace the parts which are damaged or in bad shape with new parts. Be very careful not to damage the high performance thermal insulation when removing and mounting the heater.

Model Type	TTB-E Duo 08+	TTB-E Duo 17+	TTB-E Duo 26+	TTB-E Duo 34+
Nominal Power (W)	850	1700	2550	3400
Nominal Voltage	230 V 1 N~ 50 Hz			
Nominal charge	6,8	13,6	20,4	27,2
Maximum nominal charge acceptance (kWh)	7,5	15,5	23,2	30,9
Dimensions (mm)				
Width	460	670	880	1090
Height	720	720	720	720
Depth	185	185	185	185
Total Weight (kg)	50	88	127	166
Weight of Housing (kg)	18	24	31	38
Amount of Brick Packages No. 07	2	4	6	8
Weight of Core (kg)	32	64	96	128
Amount of Heating Elements (W)	1 x 850	2 x 850	3 x 850	4 x 850
Additional Heater	500 W	500 W	750 W	750 W

Getting the most out of your storage heater:

- The most important steps when first operating your storage heater are setting the charge periods and heating schedule.
- The storage heater will aim to satisfy both the set temperatures of the schedule and the charging required to meet the needs of the schedule in the charging periods set.
- In some cases, these two aims can come into conflict.
- If you have set the heater to maintain a high room temperature whilst charging, you may find it takes longer to charge up because it has had to operate with the vent open to raise the temperature of the room. A solution to this is to enable the direct heating resistor to work in off-peak periods. This will top up the room temperature without slowing the rate of charge. Alternatively, you could set the heater to a lower economy temperature during charging intervals.
- In most cases, the process of charging will raise the room temperature to a comfortable level without requiring the resistor. In fact, the demands of charging can cause the room temperature to rise up to 3 °C above your set temperature. These higher temperatures are necessary to ensure the heater has sufficient charge to last until the next charging period.

2 Operation Manual









2.1 Screen and buttons

GB

The heater has a TFT screen and 4 buttons to control the device:

- “+” Raise temperature. Navigate up in the menu.
- “-” Lower temperature. Navigate down in the menu.
- “Mode / OK” Change mode. Select in the menu.
- “Config. / Prog.” Press 5 seconds to open settings. Go back in the menu.

2.1.1 Screen icons

Icon	Description
	Charging
	Charge percentage
	Additional heating element activated
	Fan activated (Depending on model)
	Additional heating element and fan activated (Depending on model)
	Inner air outlet for faster heating activated.
	Additional heating element and inner air outlet activated
	Device linked with Smartbox

2.2 Operation modes

The device has 4 operation modes:

- Manual Mode (Fixed Temperature)
- Program Mode (Weekly Schedule)
- Boost Mode
- OFF Mode

GB

When you first use the heater, you should choose via the advanced settings whether you want to run it in Fixed Temperature or Weekly Schedule mode:

Hold the “Config” button down to reach the settings menu. Use the “+”, “-” and “OK” buttons to navigate the menu. Go to Advanced, then Device Type. Use the “+” and “-” keys to select your preference and press OK to confirm.

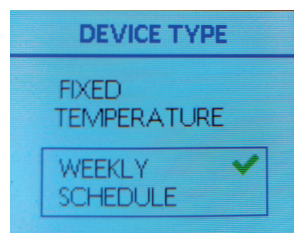

To toggle between OFF and Manual/Program (depending on which you’ve set) use the “OK” button. To use the Boost mode, press “+” or “-” during normal operation.

2.2.1 Manual Mode (Fixed Temperature)

To use the heater in Manual Mode, first select “Fixed Temperature” under “Device Type” in the settings menu. (See 2.2)

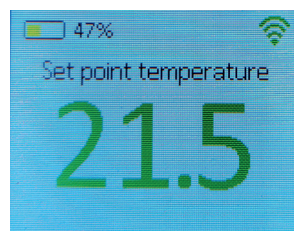

In this mode the storage heater heats at a fixed temperature. You can use the “+” and “-” buttons to select your desired temperature. Press “OK” to confirm. The heater will then give you a choice of time spans for the new temperature (as per Boost mode). Select “always” to permanently change the temperature and press “OK” to confirm.

2.2.3 Program Mode (Weekly Schedule)

In this mode the device follows a set schedule, which can be adjusted via the settings menu. See 2.5.3. The schedule consists of three temperature values which can be assigned to each hour: Comfort, Eco and Anti-Frost. You can adjust the temperature of each value in the settings menu. See 2.5.1. The program mode display shows you where you are in your schedule and which mode is running.

Comfort = 3 squares, Eco = 2 squares, Anti-Frost = 1 squares.

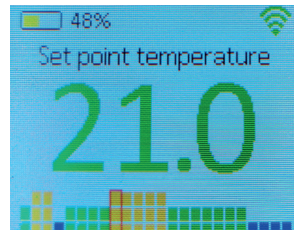

Program mode is the default operating mode of the storage heater. To change to Manual, navigate to “Device Type” in the settings menu and select “Fixed Temperature”. See 2.2.

2.2.3 Boost Mode

You can use Boost Mode to override the current temperature, whether the storage heater is on Manual or Program mode. Pressing “+” or “-” allows you to set up a boost period. Use the “+” or “-” buttons to select your desired temperature and press “Config” to confirm. Use “+” or “-” to set the duration: 1 to 5 hours, “all day” or “always”, and press “Config” to confirm.

NOTE – “always” is only available when you’re using the heater on Manual mode.

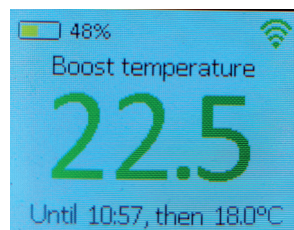

2.2.4 OFF Mode

In OFF Mode the device is switched off, it does not charge and does not heat. This mode is selected using the “Mode / OK” key. For those users who have an app connection, the ambient temperature will be recorded also in OFF mode.

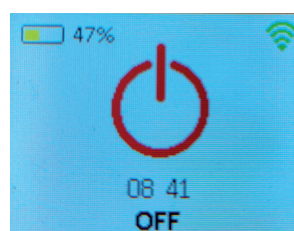

2.3 Device Linking

Users who use the mobile application “TTi Smart Control” by Technotherm (available for Android and iOS) must link the device to the control unit. To do this, follow the instructions below.

GB



Install TTi Smart Control App

Click on Install

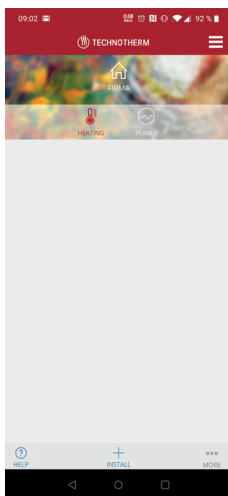

Choose Storage heater

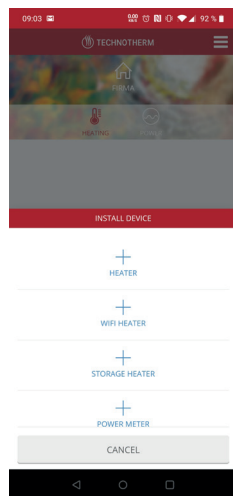

Start Search in app and press “Mode / OK” button on the device for 5 seconds

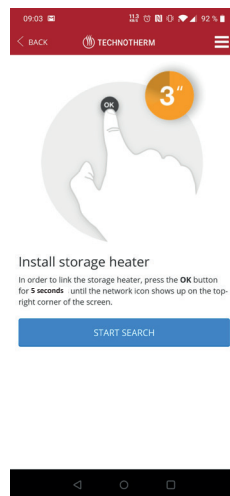

Heater appears in the app and the “Device correctly linked” icon is shown on the screen of the device

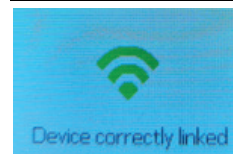
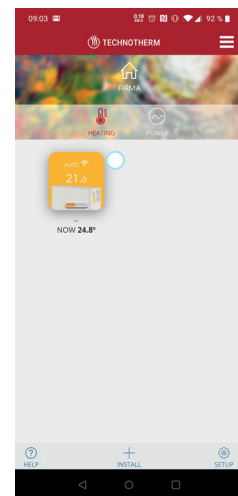

The minimum phone requirements to run your app (version 1.6.1) are:

IOS: 12.2

Android: 6.0

As an alternative, we have provided a link for you to operate your heater via your desktop.

<https://ttiapp.technotherm.com>

2.4 Keypad Lock

You can lock the keypad of the device. To do this press the “+” and “-” buttons simultaneously for 3 seconds. The following image will appear on the screen. To unlock press the “+” and “-” buttons at the same time for 3 seconds again.



GB

2.5 Device Settings

To configure the device settings press the “Config. / Prog.” button 5s. The following screen is displayed

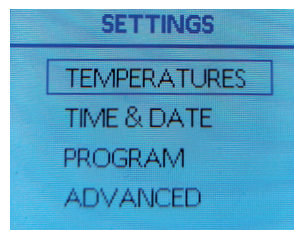

Use the “+” and “-” buttons to scroll through the menu. To select an option, press the “Mode / OK” key. To confirm and go back, press the “Config. / Prog.” Button.

2.5.1 Temperature Settings

In this menu Comfort, Eco and Anti-Frost temperatures can be adjusted. By default, these temperatures are 19.5°C, 17°C and 5°C. Each temperature can take a value from 5°C to 35°C, taking into account that temperatures should be in the order: Comfort > Eco > Anti-Frost.

This menu is only available if Automatic Mode is activated.

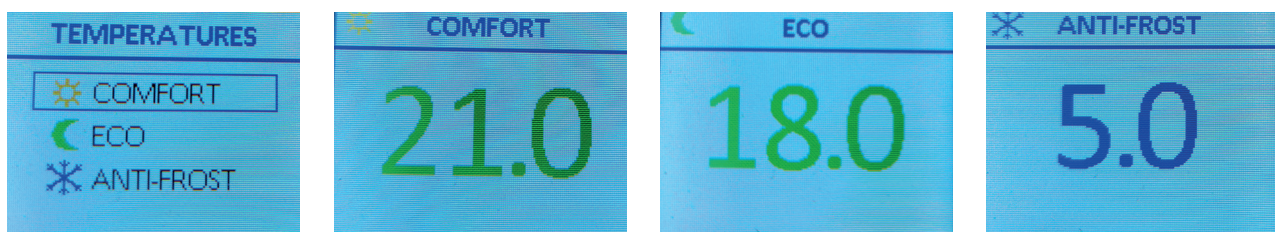

2.5.2 Time & Date Setting

In this menu you can set the day and the time, as well as the formats. Use the “Mode / OK” button to enter the submenu and “ Config. / Prog.” to exit it.

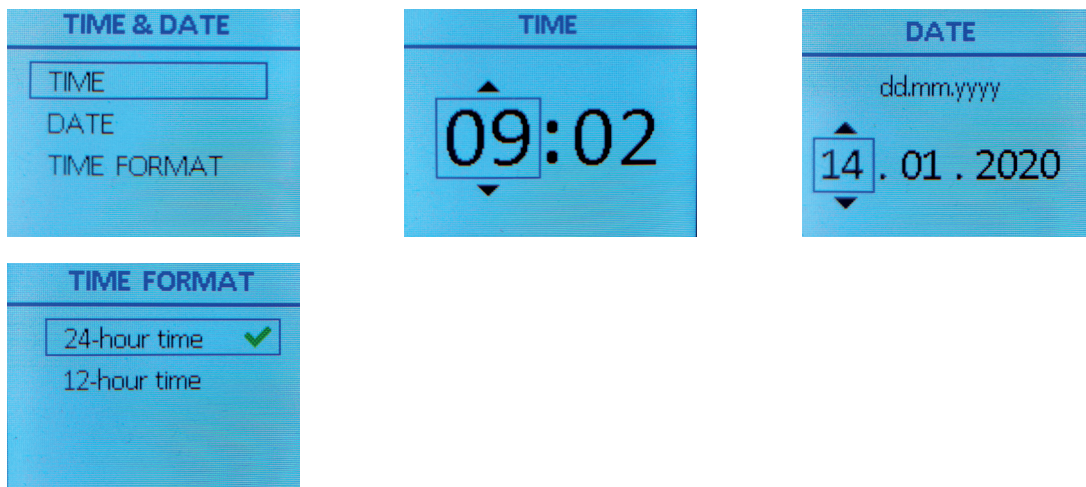

2.5.3 Program Schedule

In this menu you can adjust the daily schedule, 7 days a week.

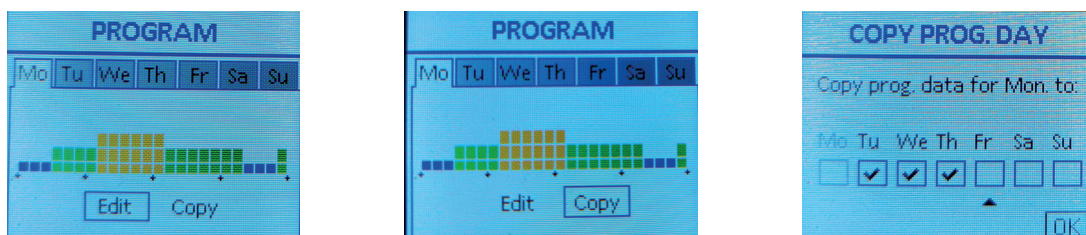

Select the day with the “+” and “-” button. Press “Mode / OK” to edit or copy the selected day.

In the edit option, you can change the daily schedule. Use „+“ and „-“ to move between the hours of the day. Press „Mode / OK“ repeatedly to adjust the temperature level. Comfort = 3 squares, Eco = 2 squares, Anti-Frost = 1 squares. Once the temperature levels have been selected for each hour, press the “Config. / Prog.” button to confirm the programming.

In the copy option, you can duplicate the schedule from one day to another. By using “+” and “-” you can navigate to a day you want to copy. Press “Mode / OK” and press “+” to select “copy”. Press “Mode / OK” again and the screen asks you, to which day you want to copy the settings. With “+” and “-” you can go to the desired days and choose them with “Mode / OK”. If you see ticks on all days you want to change press “Config. / Prog.” to confirm the copied programming.

2.5.4 Advanced Settings

2.5.4.1 Device Type

In this option you can set the operation mode. Choose between fixed temperature (Manual Mode) or weekly schedule (Automatic Mode). By default, the device is configured in Automatic Mode.

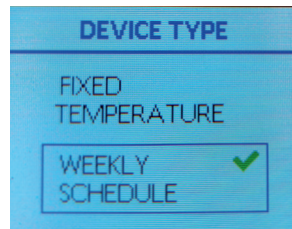

GB

2.5.4.2 Frost Protection

You can enable or disable the frost protection function. With frost protection the device starts to heat when the room temperature drops to 3°C and keeps it at that level. If enabled, it even works when the device is in OFF mode.

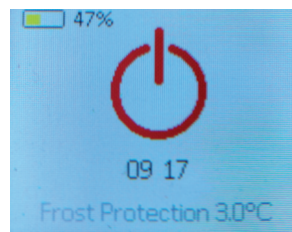
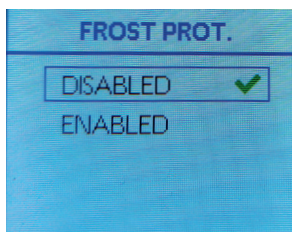

2.5.4.3 Program Resolution (Programming blocks)

This option allows the user to choose between programming in blocks of 60 minutes (One Hour) or in blocks of 30 minutes (Half Hour).

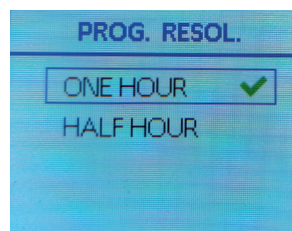

2.5.4.4 Charge Configuration

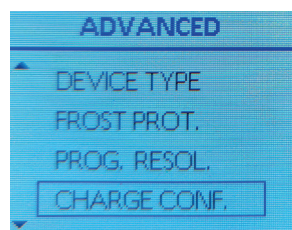

2.5.4.4.1 Resistor Configuration

In this menu you can configure the behaviour of the additional heating element which is a resistor used as backup to the charged ones.

Available values are:

- **DISABLED:** Additional heating element is not used.
- **PEAK & OFF-PEAK:** Additional heating element used in off-peak as well as peak intervals (not recommended due to high energy consumption).
- **OFF-PEAK ONLY:** Additional heating element used only in off-peak intervals (inside the charging schedule). Not recommended.
- **PEAK:** Additional heating element used only in peak interval (outside the charging schedule). Peak only is the default setting.

GB

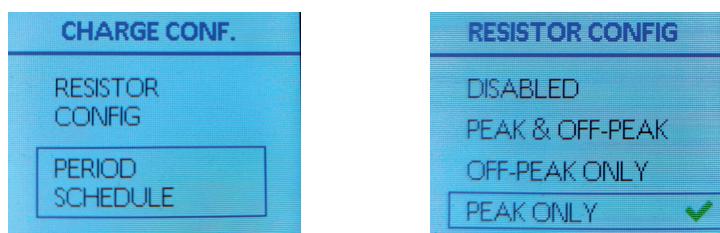

2.5.4.4.2 Period Schedule

In this submenu you can configure the periods in which the device can carry out a charge and the days it performs it. You can choose up to 2 charging periods. Use “+” and “-” to navigate, “Mode / OK” to select and “Config. / Prog.” to confirm your programming. Note that the charging periods are the same for all selected days.

Note:

If you’re using your storage heaters with an Economy tariff, make sure you match the charge periods to the periods specified by the terms of your tariff.

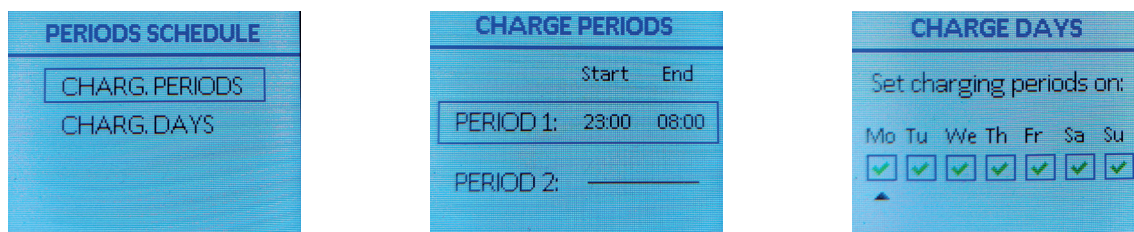

2.5.4.5 Units

The user can choose between degrees Celsius °C or Fahrenheit °F. The default setting is Celsius °C.

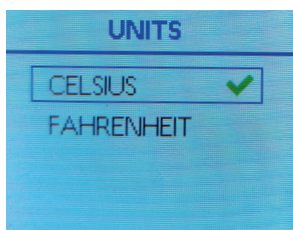

2.5.4.6 Display

In this section, the user can choose how he wants the screen to be displayed. He can choose the backlight time, the brightness if the screen is ON or OFF and the style.:

- Time ON: The time that backlight is active after a button was pressed. Default 10s.
- Brightness ON: Brightness level when backlight is enabled. Default 100%
- Brightness OFF: Brightness level when backlight is disabled. Default OFF
- Style: White background with black characters (default), black background with white characters, white background with coloured characters

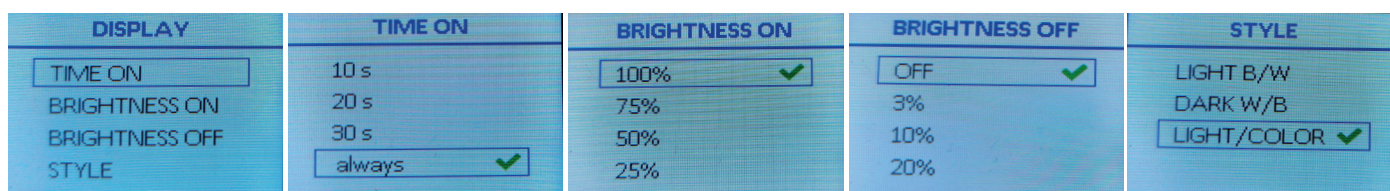

2.5.4.7 Beep

This function gives the device a short "Beep" every time a button is pressed. It can be disabled or enabled.

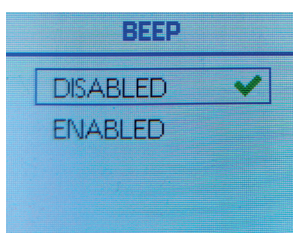

2.5.4.8 Control Type

This option allows the user to choose between different types of control, Hysteresis (on/off control) and PID (Proportional Integral Derivative) control.

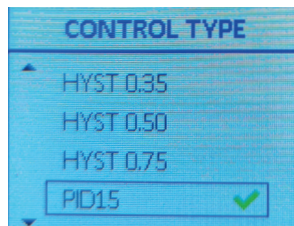

Hysteresis is the difference between on and off temperatures of the thermostat. On/Off control turns the heating element OFF at a certain value above the set room temperature and turns the heating element ON again when it falls below a certain value of the set room temperature. When using a Hysteresis of 0.5°C with a desired room temperature of 20°C the thermostat would turn OFF the heating element at 20.5°C and turn it ON again at 19.5°C.

PID temperature control is a loop control feature to improve the accuracy of the process above. It calculates the difference between the desired setpoint temperature and the current temperature, then predicts how much power to use to ensure the current temperature remains as close to the setpoint as possible. It will compensate in case of a disturbance and bring the process temperature back to the setpoint, but reduce power as temperature approaches the setpoint so that it doesn't overshoot.

Available values are:

- PID 15 min (Default)
- PID 30 min
- Hysteresis 0.25°C
- Hysteresis 0.35°C
- Hysteresis 0.5°C
- Hysteresis 0.75°C

2.5.4.9 Open Window

This option temporarily stops the operation of the device if it detects a random drop of temperature (1.2°C or more in 10 minutes), interpreting that there is an open window. It starts operating again if the user presses any button or the room temperature increases again by 0.3°C or more in 10 minutes. The user can disable or enable this option. The default value is disabled.

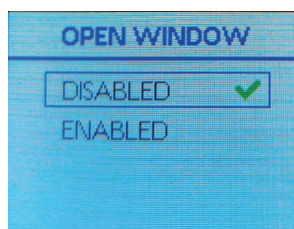

2.5.4.10 Smart Start (Adaptive Start)

This option modifies the behavior of the device, learning from habits, to reach the setpoint temperature at the scheduled time. The user can disable or enable this option. It only works in automatic mode. The default value is disabled.

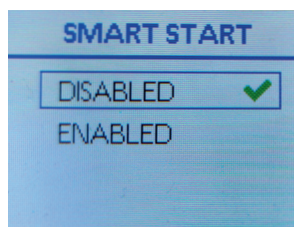

2.5.4.11 Offset

This option allows the user to calibrate the room temperature probe. Since the accuracy of the probe is 0.1°C, there may be some discrepancy in the reading of the ambient temperature between thermostats. An error margin of up to +/- 3°C can be calibrated. The default value is 0.0°C.

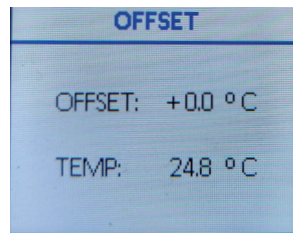
GB

2.5.4.12 Parameters

This option is for use of service engineers only! Do not change any parameters by yourself. Changing parameters „e.g. how hot is a 100% charge, could lead to dysfunction of the device and could be very dangerous!“

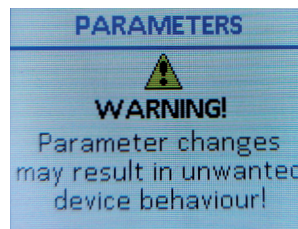

2.5.4.13 Language

With this option the user can change the language on the screen. You can choose one of the three available languages.

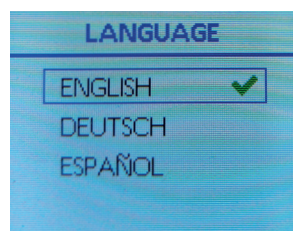

2.5.4.14 Reset

This option allows the user to return to the factory settings. All recorded information, including the link to the Smartbox, are lost and reset to default values.

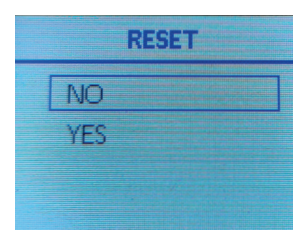

Report a case to the after-sales service

Your storage heater was carefully manufactured and checked repeatedly before dispatch. If you should nevertheless encounter a problem or have questions concerning handling, feel free to contact us.

From Jan 1st 2018, the EU-conformity of these devices is additionally bound to fulfilment of the Eco-Design Requirements 2015 /1188.

GB

Installation and starting up of the equipment is only permitted in conjunction with external room temperature controllers which fulfil the following functions:

- electronic room temperature control depending on the weekday and, at least, has one of the following characteristics:
- Room temperature control with detection of an opened window
- With remote control option
- With adaptive start control

The following room temperature control systems supplied by Technotherm

- Duo-E Duo+ Thermostat

fulfil the following requirements and thus the ErP Directive:

- electronic room temperature control depending on the weekday
- with remote control option
- with detection of an opened window
- adaptive control of the heating start

For installation and use of the Technotherm thermostats and interfaces, please refer to a separate manual. The manual can be requested at the Customer Service - see the last page.

If this requirement is not fulfilled, the device will lose its CE marking.

Information requirements for electrical room heaters

Type: TTB-E Duo													
Designation	Symbol	Rate									Unit	Designation	Unit
Heating capacity											Type of heat supply, only for electrical storage heaters in rooms (select one type)		
Nominal thermal output	P_{nom}	0.85	1.7	2,55	3,4						kW	Manual thermal charge control, with integrated thermostat	NO
Minimal thermal output (indicative)	P_{min}	0.85	1.7	2,55	3,4						kW	Manual thermal charge control with acknowledgement of the room inside and /or outside temperature	NO
Maximum continuous thermal performance	$P_{max,c}$	0.85	1.7	2,55	3,4						kW	Electronic charge control with acknowledgement of the room inside and /or outside temperature	Yes
Auxiliary current consumption											Heating power supported with a fan		NO
At nominal thermal output	$e_{l_{max}}$	0.85	1.7	2,55	3,4						kW	Type of heating power / room temperature Control (select one type)	
At the minimum heating capacity	$e_{l_{min}}$	0.85	1.7	2,55	3,4						kW	Single-stage heating capacity; no room temperature control	NO
At the standby mode	$e_{l_{SB}}$	0.8	0.8	0.8	0.8						Watt	Two or more manual stages, no room temperature control	NO
												With mechanical room temperature control	NO
												With electronic room temperature control	NO
												Electronic temperature control in the room, depending on the time of day	NO
												Electronic temperature control in the room, depending on the weekday	YES
											Other control options (multiple choice is possible)		
												Room temperature control with presence detection	NO
												Room temperature control with detection of an opened window	YES
												With remote control option	YES
												With adaptive start control	YES
												With limitation of heating time	NO
												With a black lamp sensor	NO
Contact information:	Lucht LHZ Elektroheizung GmbH & Co. KG Reinhard-Schmidt-Str.1 D-09217 Burgstädt, Germany												



GB

TECHNOTHERM After-sales service:
Ph. +49 911 93 78 32 10

Technical alternations, errors, omissions and errata reserved. Dimensions are stated without warranty! Updated: 02/20

TECHNOTHERM is a trademark of Lucht LHZ GmbH & Co. KG
Reinhard Schmidt-Str. 1 | 09217 Burgstädt, Germany
Phone: +49 3724 66869 0
Telefax: +49 3724 66869 20
info@technotherm.de | www.technotherm.de